

B

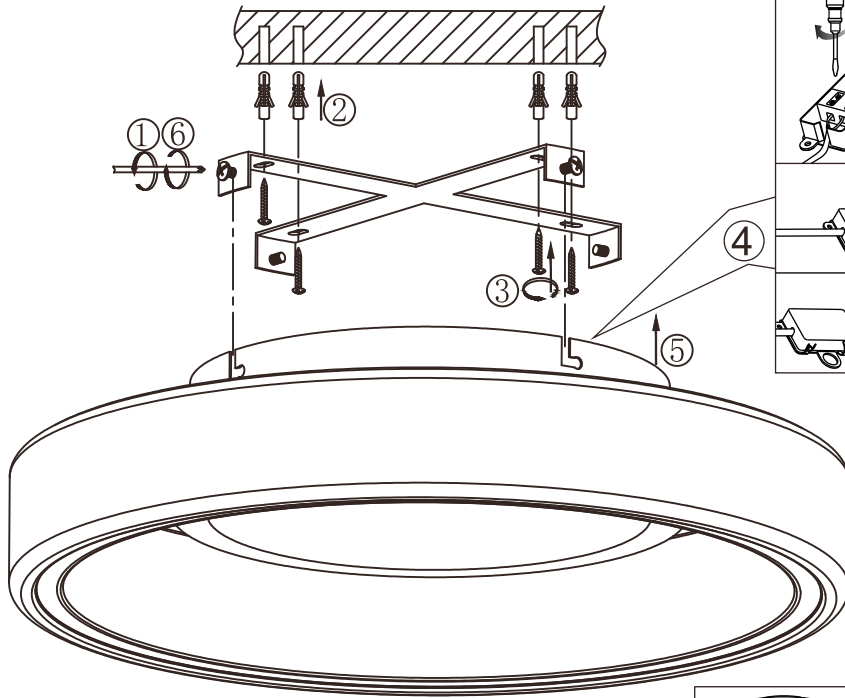

GLOBO

LIGHTING

www.globo-lighting.com

48398-40

Frequency Bandwidth	Maximal radiation Transmitting power
2.402GHz-2.480GHz	0dBm

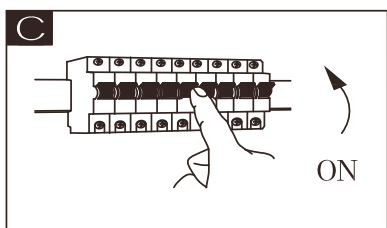
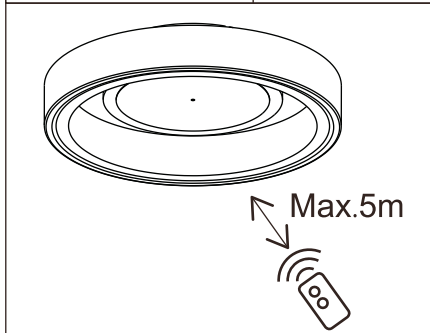
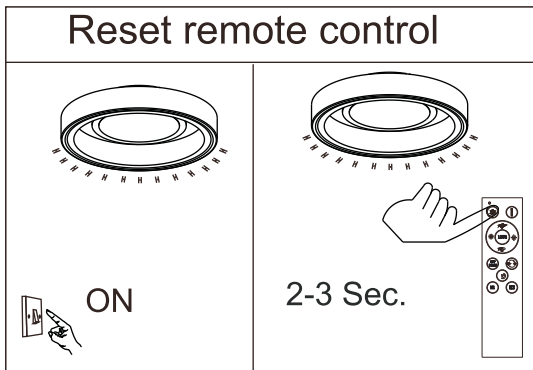

- incl.
- 3 LIGHT STEPS (4000K, 3000K, 6500K)
- dimmable
- 3000 K - 6500K
- night light
- many steps
- colour fixing
- memory function
- many light steps
- timer

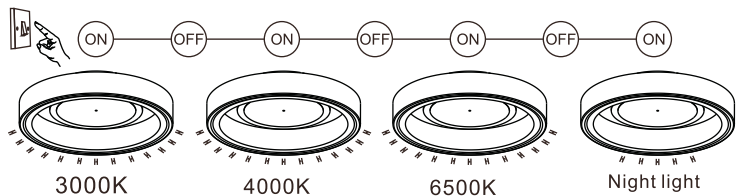
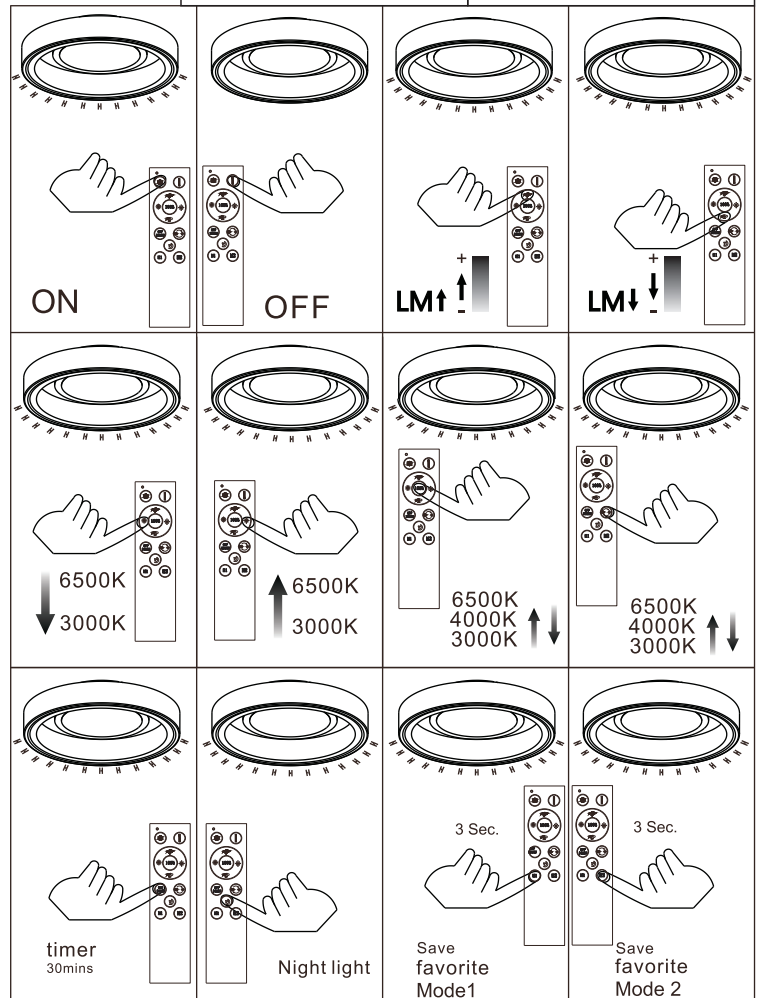

GLOBO Handels GmbH
 Gewerbestr. 3
 A-9184 Sankt Peter Austria

Lichtquelle:

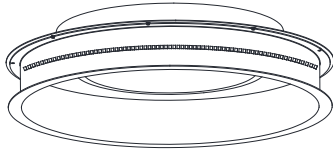

DEU:

Lichtquelle:

Die Lichtquelle ist nicht tauschbar, weil sie konstruktionsbedingt fest mit dem umgebenden Produkt verbunden ist.

Dieses Produkt enthält eine Lichtquelle der Energieeffizienzklasse <E>.

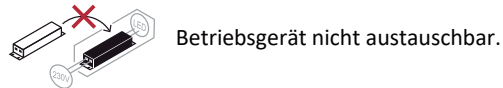

Betriebsgerät nicht austauschbar.



Leuchtmittel nicht austauschbar.

GBR:

Light source:

The light source is not interchangeable because it is determined by the surrounding product design. This product contains a light source of energy efficiency class <E>.

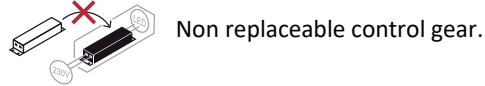

Non replaceable control gear.

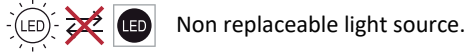

Non replaceable light source.

BIH:

Izvor svjetla :

Izvor svjetla nije zamjenjiv , jer je konstrukcijski pričvršćen na proizvod . Ovaj proizvod sadržava izvor svjetlosti klase energetske učinkovitosti <E>.

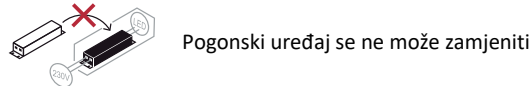

Pogonski uređaj se ne može zamjeniti

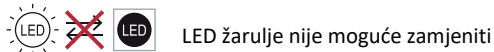

LED žarulje nije moguće zamjeniti

BG:

Източник на светлина:

Източникът на светлина не може да се подменя, тъй като поради конструкцията си е трайно фиксиран към заобикалящия го продукт.

Този продукт включва светлинен източник с клас на енергийна ефективност <E>.

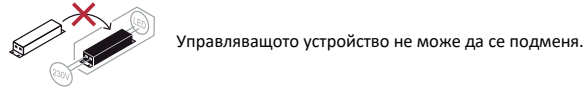

Управляващото устройство не може да се подменя.

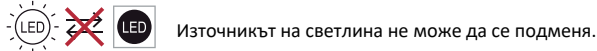

Източникът на светлина не може да се подменя.

CZ:

Zdroj světla:

Světelný zdroj není možné vyměnit, protože je díky své konstrukci pevně spojený s produktem.

Tento výrobek obsahuje světelný zdroj s třídou energetické účinnosti <E>.

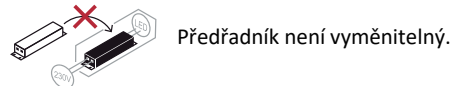

Předřadník není vyměnitelný.

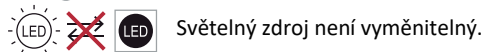

Světelný zdroj není vyměnitelný.

DK:

Lyskilde:

Lyskilden kan ikke udskiftes, fordi den er fast forbundet med det omgivende produkt. Dette produkt indeholder en lyskilde i energieffektivitetsklasse <E>.

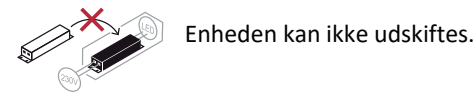

Enheden kan ikke udskiftes.

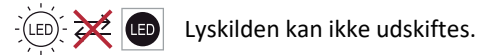

Lyskilden kan ikke udskiftes.

ET:

Valgusallikas:

Valgusallikas ei ole välja vahetatav, sest ta on tootega ehituslikult kindlalt seotud.

Toode sisaldab energiatõhususe klassi <E> valgusallikat.

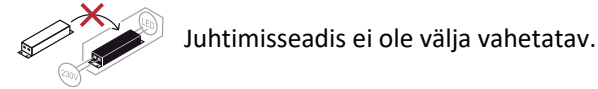

Juhtimiseadis ei ole välja vahetatav.

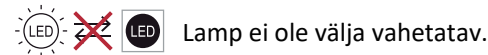

Lamp ei ole välja vahetatav.

FI:

Valonlähde:

Valonlähdettä ei voi vaihtaa uuteen, sillä se on rakenteellisesti yhdistetty ympäröivään tuotteeseen.

Tämä tuote sisältää valonlähteen, jonka energiatehokkuusluokka on <E>.

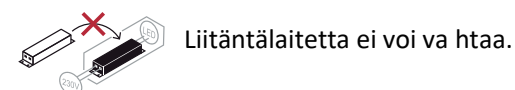

Liitäntälaitetta ei voi vaihtaa.

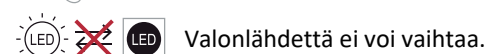

Valonlähdettä ei voi vaihtaa.

FR:

Source lumineuse:

La source lumineuse n'est pas remplaçable car elle est, de par la construction du produit, liée de façon permanente à celui-ci.

Ce produit contient une source lumineuse de classe d'efficacité énergétique <E>.

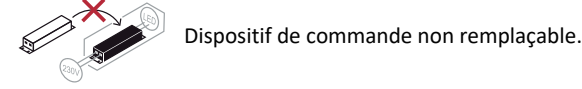

Dispositif de commande non remplaçable.

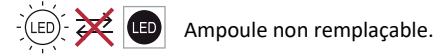

Ampoule non remplaçable.

GR:

Φωτεινή πηγή:

Η φωτεινή πηγή δεν μπορεί να αντικατασταθεί, επειδή είναι για κατασκευαστικούς λόγους σταθερά συνδεδεμένη με το προϊόν που την περιβάλλει.

Το προϊόν αυτό περιέχει φωτεινή πηγή της τάξης ενεργειακής απόδοσης <E>.

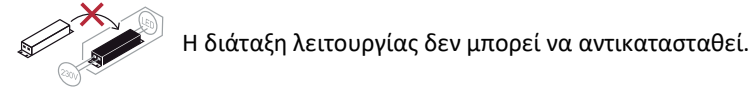

Η διάταξη λειτουργίας δεν μπορεί να αντικατασταθεί.

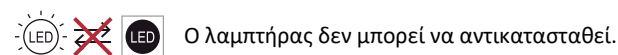

Ο λαμπτήρας δεν μπορεί να αντικατασταθεί.

HU:**Fényforrás:**

A fényforrás nem cserélhető, mert felépítése miatt szilárdan csatlakozik a termékhez. Ez a termék egy <E> energiahatékonysági osztályú fényforrást tartalmaz.

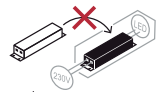

Az előtét nem cserélhető.



A fényforrás nem cserélhető.

Isländisch/IS:**Ljósgrjafi:**

Ljósgrjafinn er ekki útskiptanlegur vegna þess að hann er háður umliggjandi hönnun vörunnar.

Varan inniheldur ljósgrjafa í orkuflokki <E>.

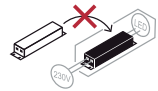

Ekki útskiptanlegur stýribúnaður.



Ekki útskiptanlegur ljósgrjafi.

IT:**Sorgente luminosa:**

La sorgente luminosa non è intercambiabile perché è saldamente collegata al prodotto per via del suo design.

Questo prodotto contiene una sorgente luminosa di classe di efficienza energetica <E>.

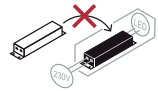

Alimentatore non sostituibile.



Lampadine non intercambiabili.

HR:**Izvor svjetla :**

Izvor svjetla nije zamjenjiv , jer je konstrukcijski pričvršćen na proizvod .

Ovaj proizvod sadržava izvor svjetlosti klase energetske učinkovitosti <E>.

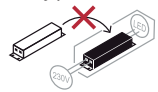

Pogonski uređaj se ne može zamjeniti

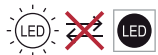

LED žarulje nije moguće zamjeniti

LV:**Gaismas avots:**

Gaismas avotu nevar nomainīt, jo tas konstrukcijā ir cieši savienots ar izstrādājuma apkārtējo daļu. Šis ražojums satur gaismas avotu, kura energoefektivitātes klase ir <E>.

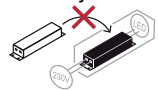

Vadības ierīci nevar nomainīt.



Apgaismes līdzekli nevar nomainīt.

LT:**Šviesos šaltinis:**

Šis šviesos šaltinis yra nekeičiamas, nes jis prijungtas prie gaminio pagal jo konstrukciją. Šiame gaminyje yra šviesos šaltinis, kurio energijos vartojimo efektyvumo klasė <E>.

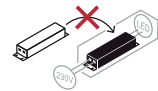

Valdymo įtaisas yra nekeičiamas.

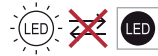

Šviesos šaltinis yra nekeičiamas.

NL:**Lichtbron:**

De lichtbron kan niet worden vervangen, omdat deze vanwege de constructie vast met het product eromheen verbonden is.

Dit product bevat een lichtbron van energie-efficiëntieklasse <E>.

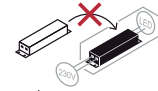

Apparaat kan niet worden vervangen.

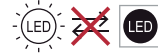

Verlichting kan niet worden vervangen.

Norwegisch/Norwegian / NO:**Lyskilde:**

Lyskilden kan ikke byttes fordi den sitter fast i produktet.

Dette produktet inneholder en lyskilde i energiklasse <E>.

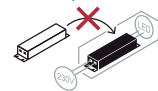

Driftsapparatet kan ikke byttes ut.

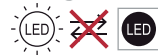

Lyskilden kan ikke byttes ut.

PL:**Źródło światła:**

Źródła światła nie można wymienić, ponieważ jest zintegrowane z produktem ze względu na swoją konstrukcję.

Ten produkt zawiera źródło światła o klasie efektywności energetycznej <E>.

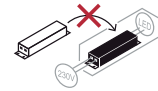

Osprzętu sterującego nie można wymienić.

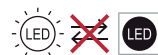

Źródła światła nie można wymienić.

PT:**Fonte de Luz:**

A fonte de luz não é substituível porque devido às suas características construtivas está fixada de forma permanente ao produto circundante.

Este produto contém uma fonte de luz da classe de eficiência energética <E>.

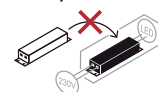

Dispositivo de comando não substituível.

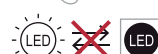

Lâmpada não substituível.

RO:**Sursa de lumina:**

Sursa de lumina nu este inlocuibilă ea fiind parte constructivă a produsului
Acest produs conține o sursă de lumină cu clasă de eficiență energetică <E>.

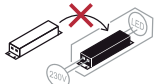

Unitatea de control nu poate fi schimbată



Sursa de lumina nu poate fi schimbată

RUS:**Источник света:**

Источник света не является взаимозаменяемым, поскольку это определяется конструкцией смежного продукта.

Данный продукт содержит источник света класса энергоэффективности <E>.

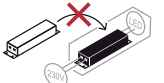

Незаменяемый регулировочный механизм



Незаменяемый источник света.

SRB:**Izvor svetlosti:**

Izvor svetlosti nije zamenljiv, jer je zbog svog dizajna čvrsto povezan sa proizvodom koji ga opkružuje.
Ovaj proizvod sadrži izvor svetlosti klase energetske efikasnosti <E>.

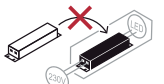

Upravljački uređaj nije zamenljiv.



Izvor svetlosti se ne može zameniti.

SK:**Zdroj svetla:**

Svetelný zdroj nie je možné vymeniť, pretože je vďaka svojej konštrukcii pevne spojený s produktom
Tento výrobok obsahuje svetelný zdroj triedy energetickej účinnosti <E>.

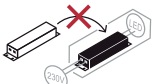

Predradník nie je vymeniteľný.



Svetelný zdroj nie je vymeniteľný.

SI:**Izvor svetlobe:**

Vir svetlobe ni zamenljiv, ker je določen z zasnovno izdelka v okolici.
Ta izdelek vsebuje svetlobni vir razreda energijske učinkovitosti <E>.

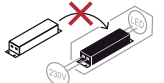

Nezamenljiv krmilnik.



Nezamenljiv vir svetlobe.

ES:**Fuente de luz:**

La fuente de luz no es sustituible porque está fija en el producto desde la construcción.
Este producto contiene una fuente luminosa de la clase de eficiencia energética <E>.

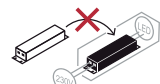

Dispositivo de control no reemplazable.



Bombilla no reemplazable.

SE:**Ljuskälla:**

Ljuskällan är inte utbytbar, eftersom den på grund av konstruktionen är fast integrerad i den omgivande produkten.

Denna produkt innehåller en ljuskälla med energieffektivitetsklass <E>.

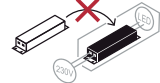

Driftdonet kan inte bytas ut.

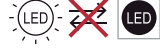

Ljuskällan är inte utbytbar.

TR:**Işık kaynağı:**

Konstrüksiyon gereği çevreyen ürün ile sabit bir şekilde bağlı olduğu için ışık kaynağı değiştirilemez.
Bu ürün, <E> enerji sınıfından bir ışık kaynağına sahiptir.

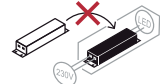

İşletme cihazı değiştirilemez.



Aydınlatma malzemesi değiştirilemez.

UK:**Джерело світла:**

Джерело світла не можна обміняти, оскільки воно міцно пов'язане з навколишнім виробом завдяки своїй конструкції.

Цей виріб містить джерело світла класу енергоефективності <E>.

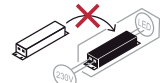

Редуктор не є змінним.

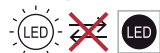

Цибулини не взаємозамінні.