

Röhr-Bush GmbH & Co. KG
Dammstraße 32
33397 Rietberg
Germany
Fon +49 (0) 2944 981 198
Fax +49 (0) 2944 981 310

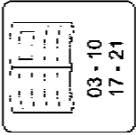

03 - 10
17 - 21

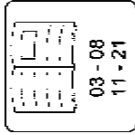
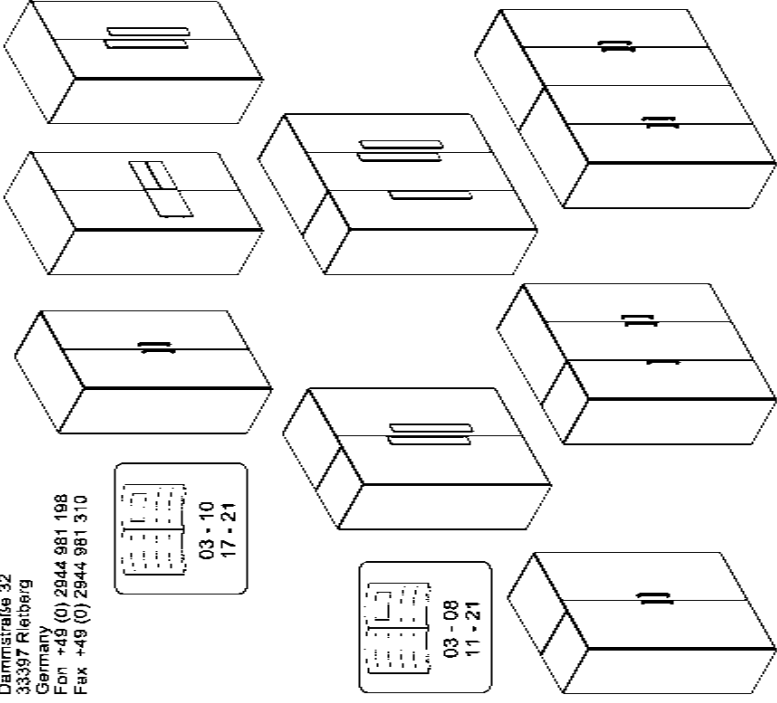

03 - 08
11 - 21

Bitte unbedingt lesen: Bei Nichtbeachtung können wir keine Gewährleistung übernehmen!
Bitte bewahren Sie diese Montageanleitung für die Produktkennzeichnung (Produktsicherheitsgesetz) und für evtl. spätere Rückfragen (wie z. B. Demontage) auf.
Bei Weitergabe bzw. Übergabe des Artikels übergeben Sie auch diese Montageanleitung.
Attention! It is essential to read this. In case of non-compliance we cannot accept any liability.
Please retain this assembly instruction for product identification and all future references e.g. disassembly.
With all transfers or deliveries of this item this assembly instruction should always be forwarded.

0091020

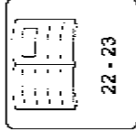

22 - 23

geteilte Türen
two part doors

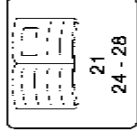
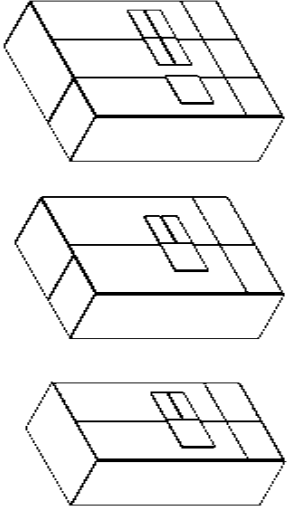

21
24 - 28

Griffe
handles

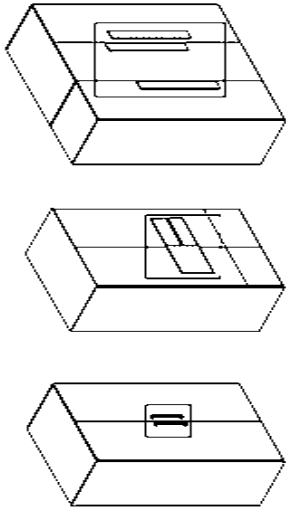

| | | | | | |
|----------------------------------|--|-----------|--|-----------|--|
| 02 096098 | | 02 096079 | | 02 096030 | |
| 02 096530 | | 02 096420 | | 02 097108 | |
| 02 066508 | | 02 096232 | | 02 096449 | |
| 02 096489 | | 02 9E3279 | | 4 x 17 | |
| Geteilte Türen two part doors | | 02 9E1946 | | 02 096469 | |
| | | 4 x 45 | | 3,5 x 15 | |
| | | | | 02 9E0384 | |
| | | | | 5, x 30 | |

Griffe variieren in
Form und Position
in den Programmier-
Anweisungen können aufgrund von abweichenden
Produktionsprozessen einen Überschuss an
Gewicht enthalten!
The content of fittings may be higher than listed
because of universal fitting-packages!

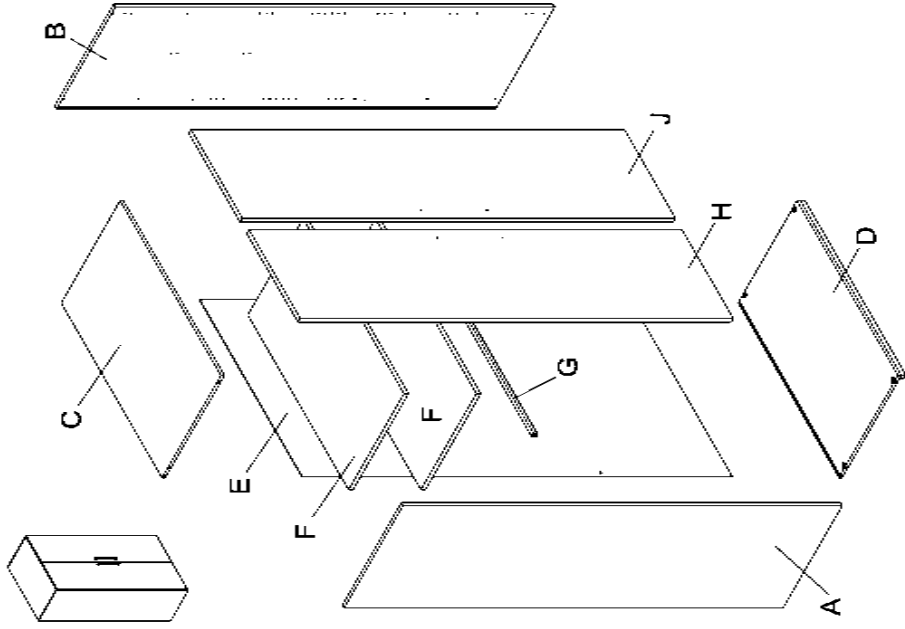
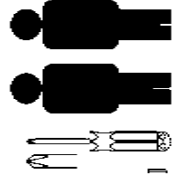

röhr

Montageanleitung
A04182.05

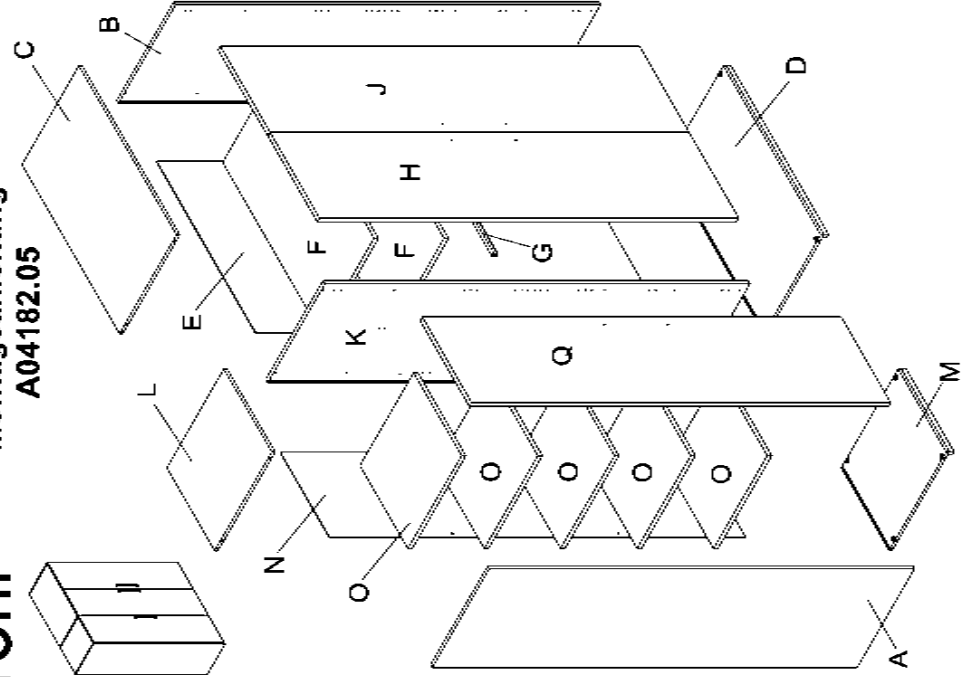
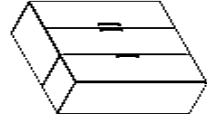

röhr

Montageanleitung
A04182.06



02096088
(2 X)

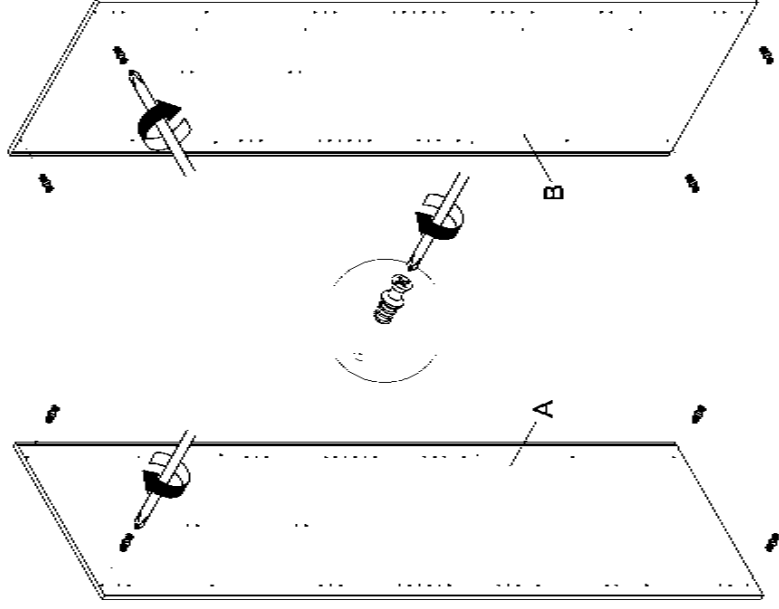

röhr

Montageanleitung
A04182.07

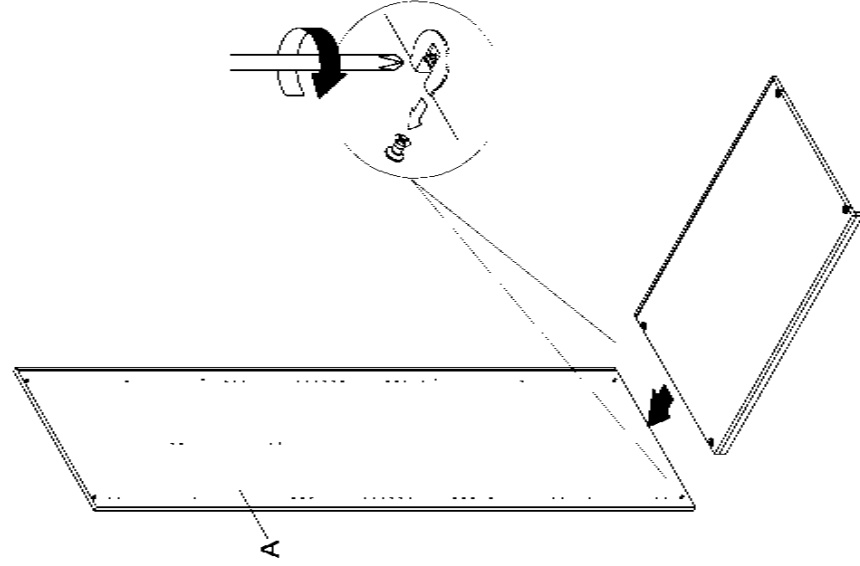

röhr

Montageanleitung
A04182.08

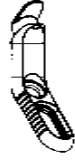

02096038
(2 X)



02096530
(2 X)

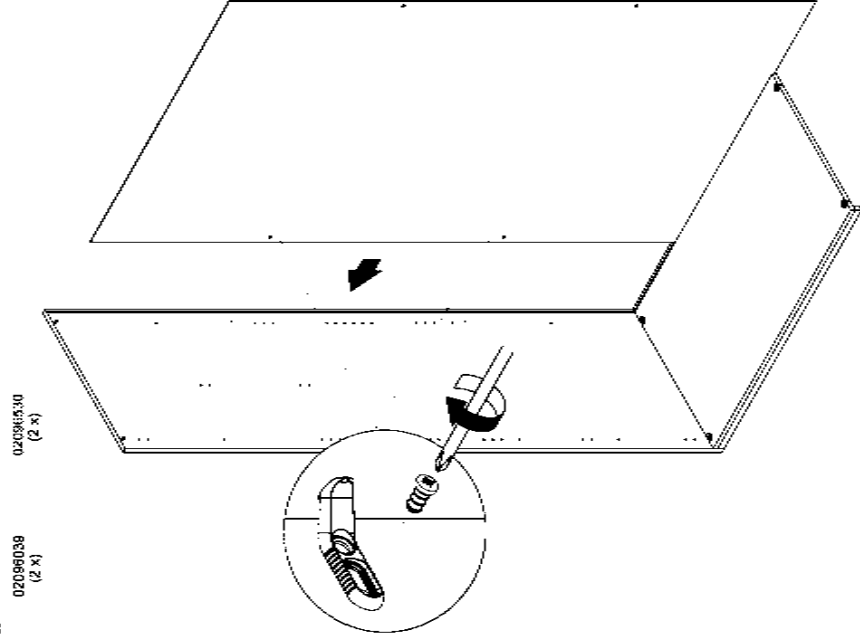

röhr

Montageanleitung
A04182.09

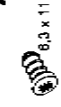
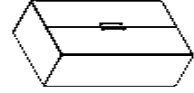

02098039
(2 X)

02098530
(2 X)

2.

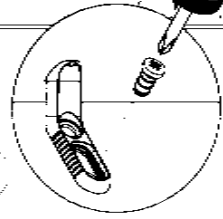

1.

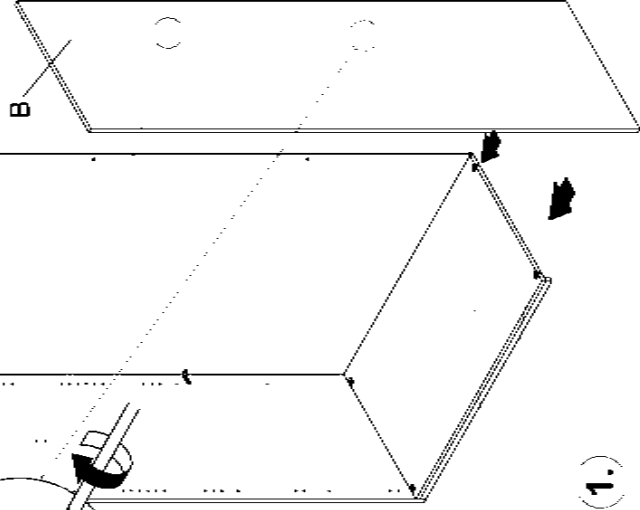
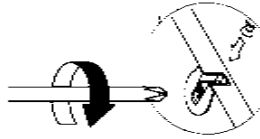

röhr

Montageanleitung
A04182.10

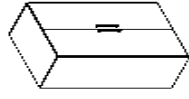

C

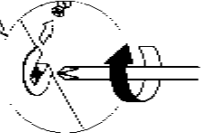
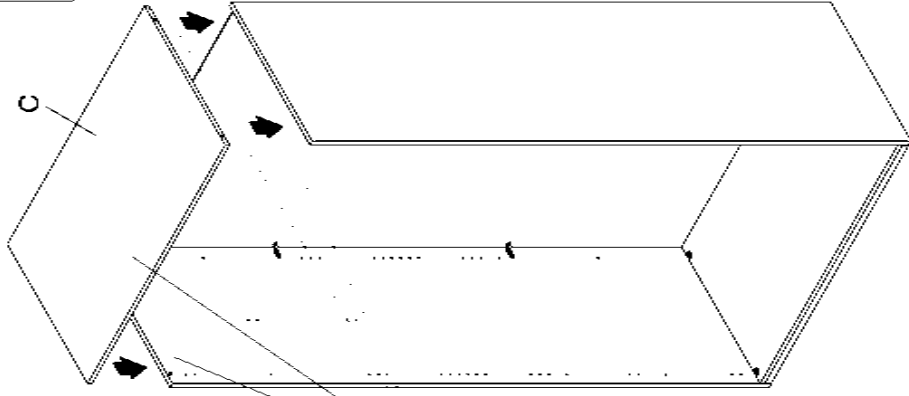

röhr

Montageanleitung
A04182.11

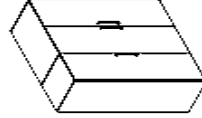

02086086
(6 X)

2.

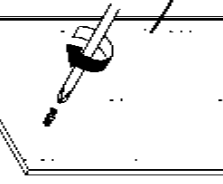

DREHEN

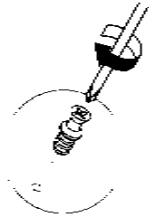

K

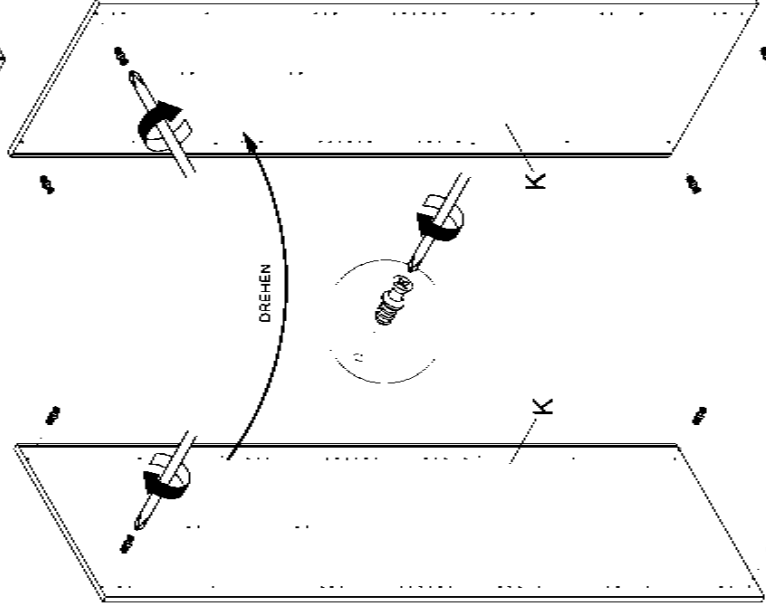

röhr

Montageanleitung
A04182.12

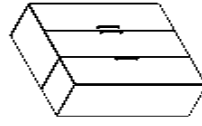

02098039
(2 X)

02098530
(2 X)

2.

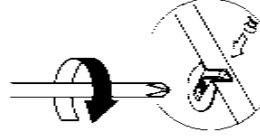
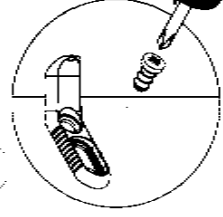

1.

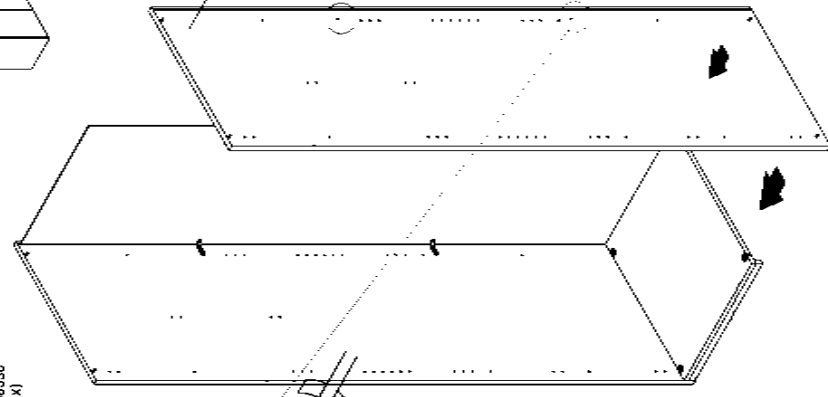

röhr

Montageanleitung
A04182.14

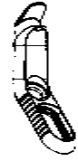

02098036
(2 x)

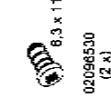

02096530
(2 x)

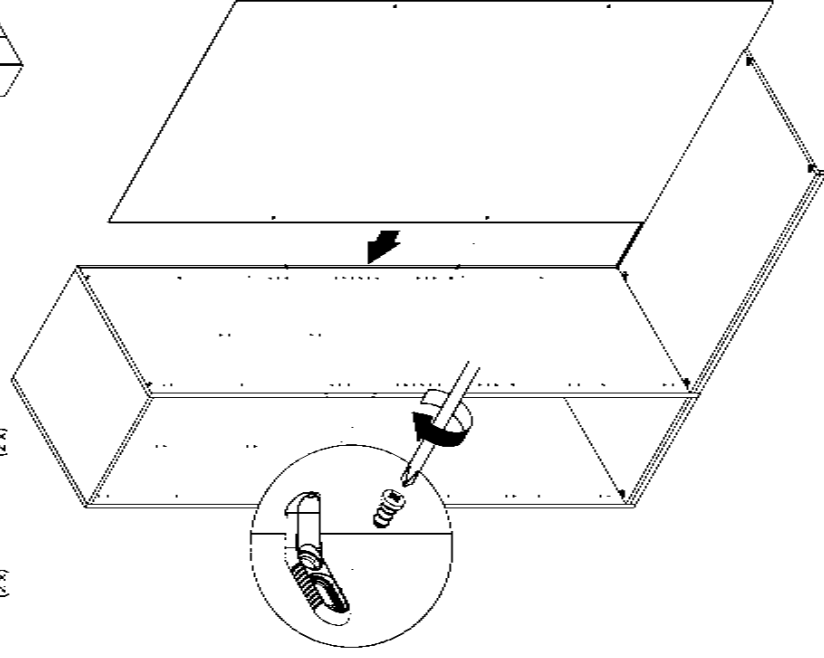
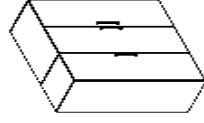

röhr

Montageanleitung
A04182.16

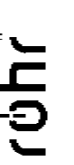

02098036
(2 x)



02096530
(2 x)

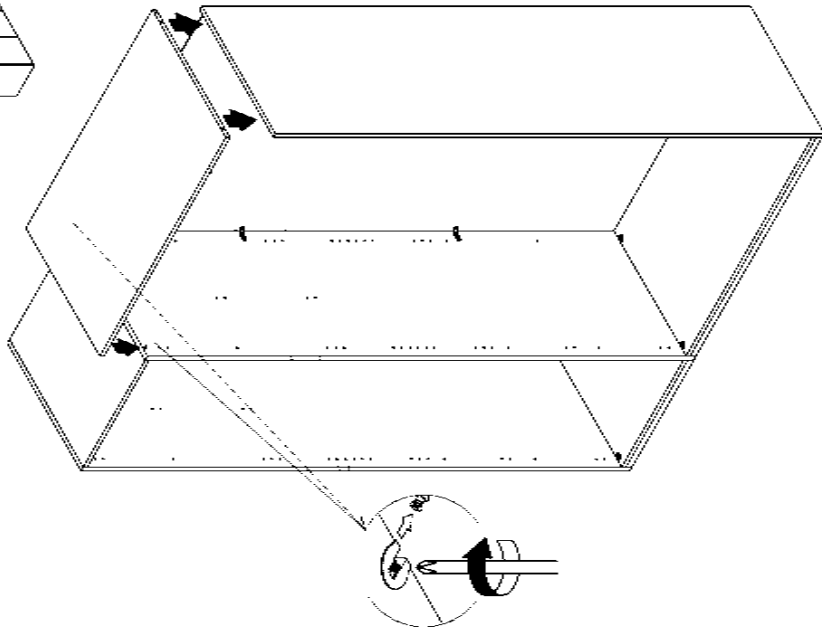
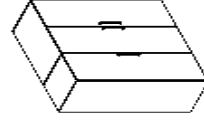

röhr

Montageanleitung
A04182.13



02098036
(2 x)

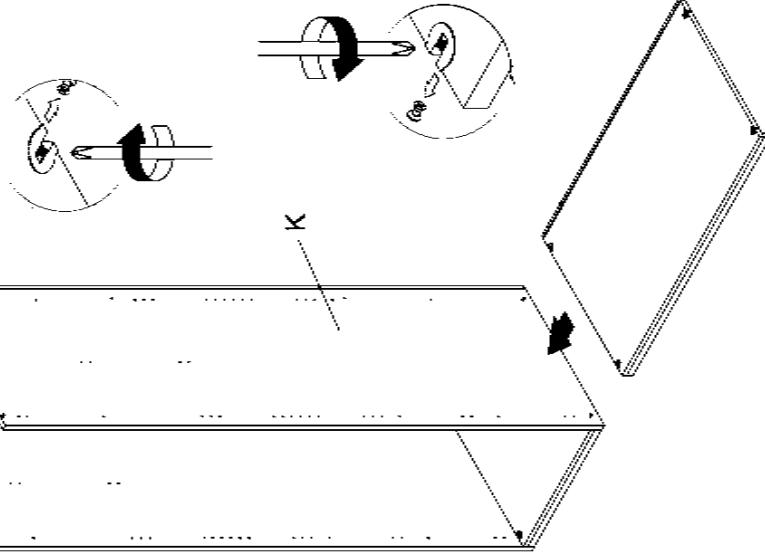
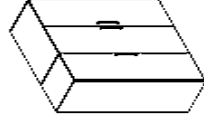

röhr

Montageanleitung
A04182.15

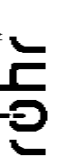

02098036
(2 x)

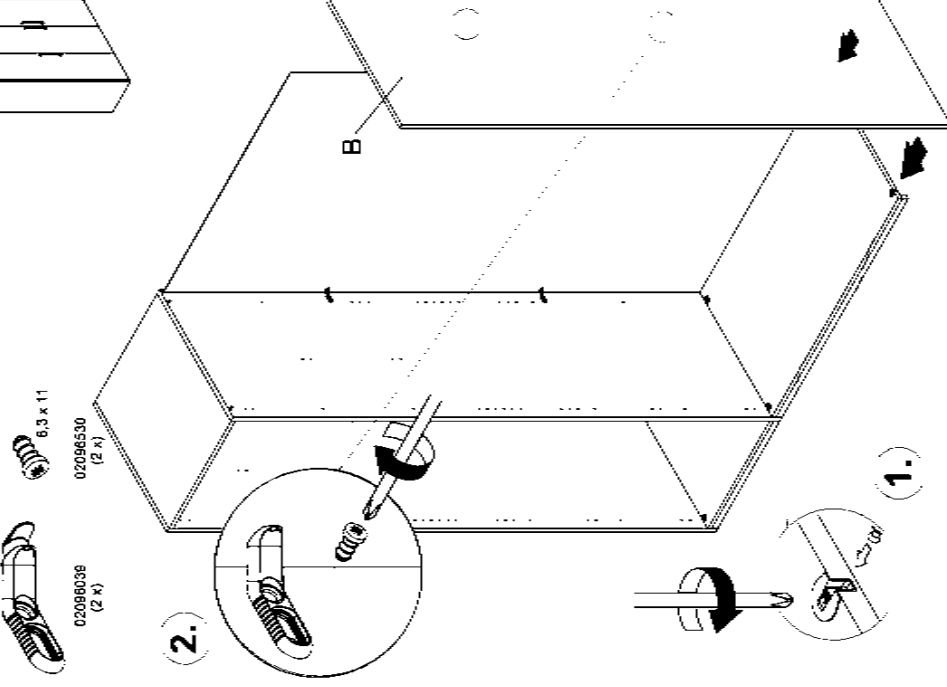
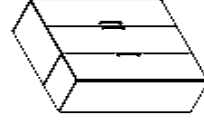

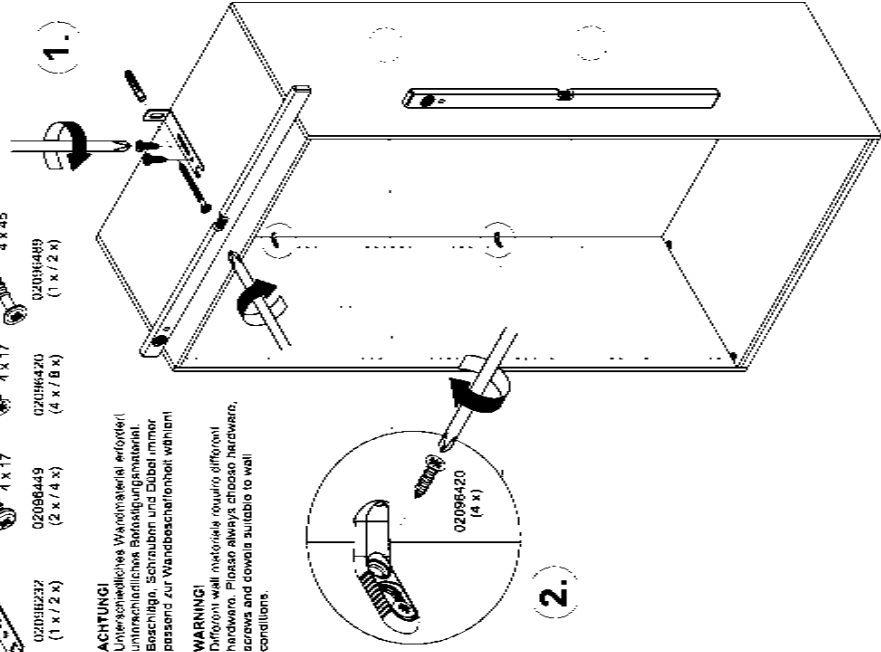
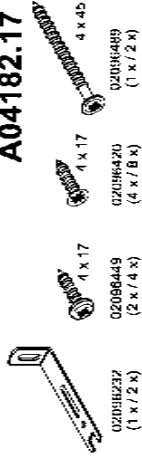
röhr**Montageanleitung
A04182.17**

ACHTUNG!
 Unter bestimmten Umständen ist die
 Unterseite des Türschwelles zu
 beschleifen. Schrauben und Dübel
 müssen für Wandbeschaffenheiten
 geeignet sein.

WARNING!
 Diffusion wall installation requires
 additional work. Under certain
 conditions, the bottom of the
 threshold must be sanded. Screws
 and dowels must be suitable for
 wall conditions.

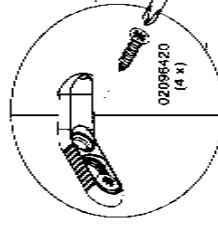
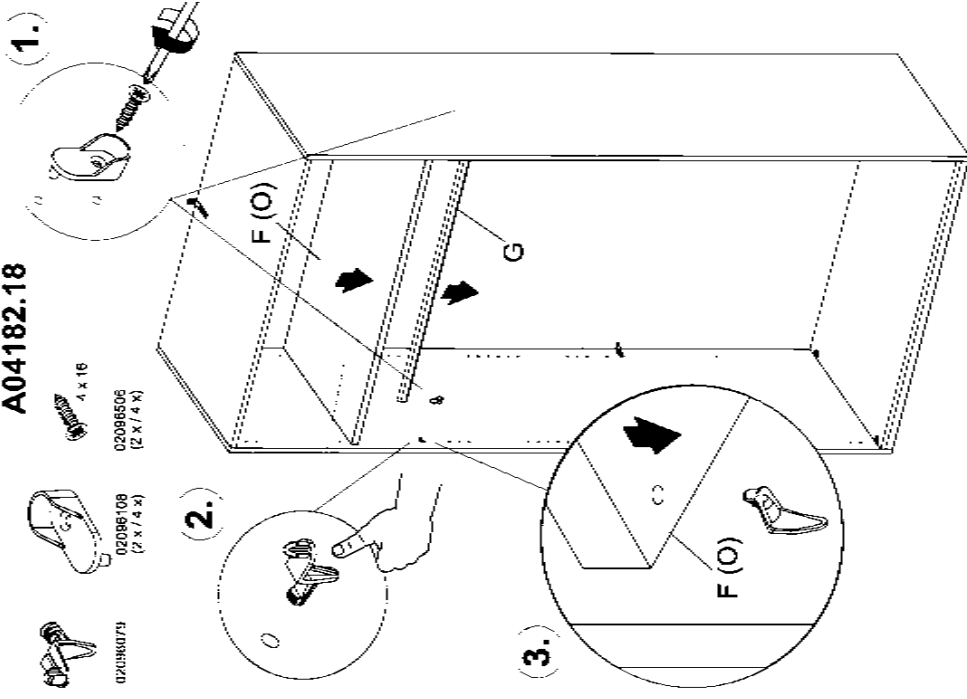
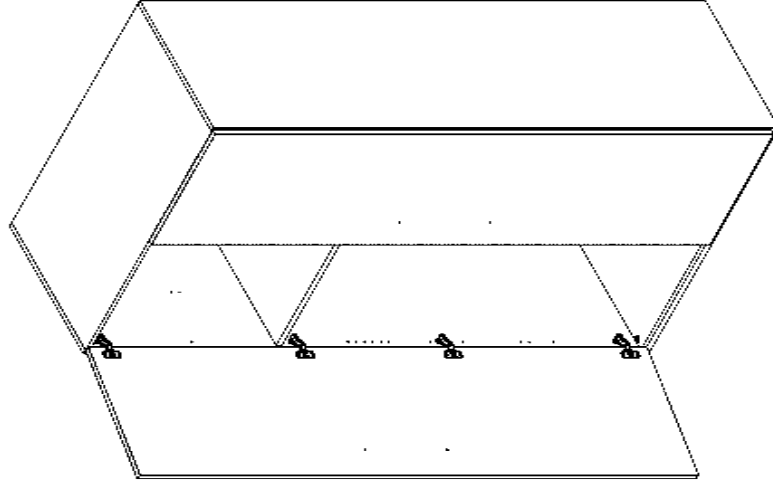
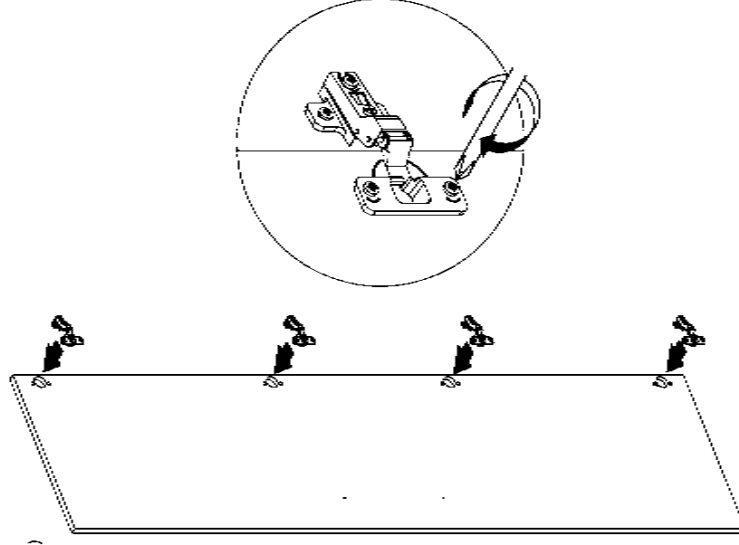
**röhr****Montageanleitung
A04182.18****röhr****Montageanleitung
A04182.19****röhr****Montageanleitung
A04182.20**

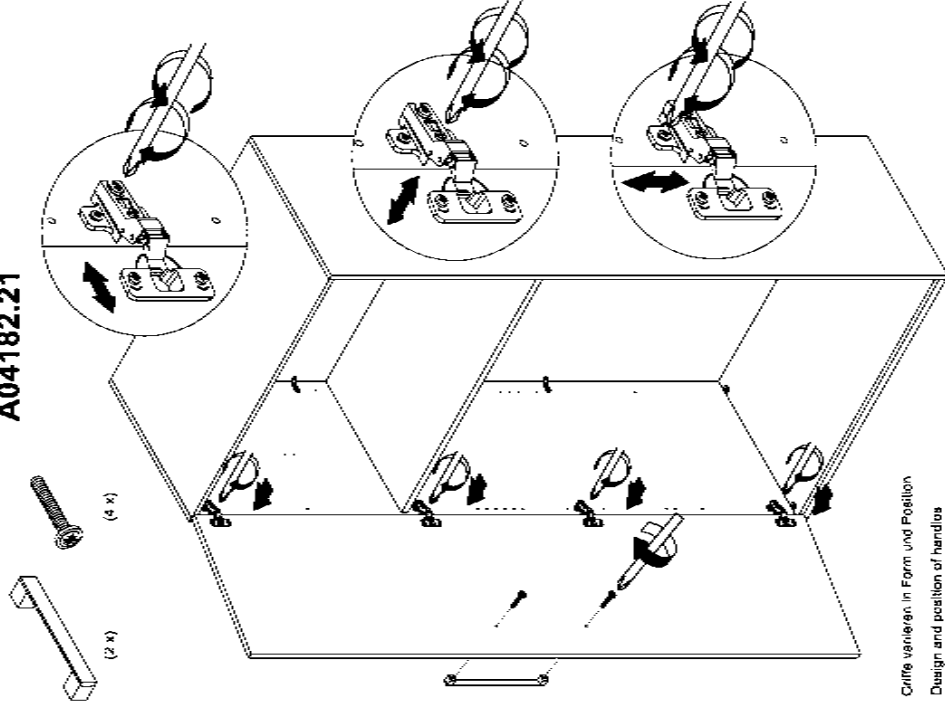

Griffe variieren in Form und Position
Design and position of handles
can be different than shown

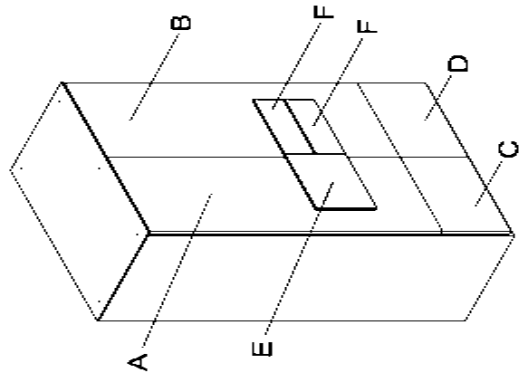

02960364



b x 30

02961846

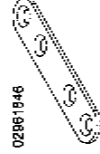

3,5 x 15

02096509



3,5 x 15

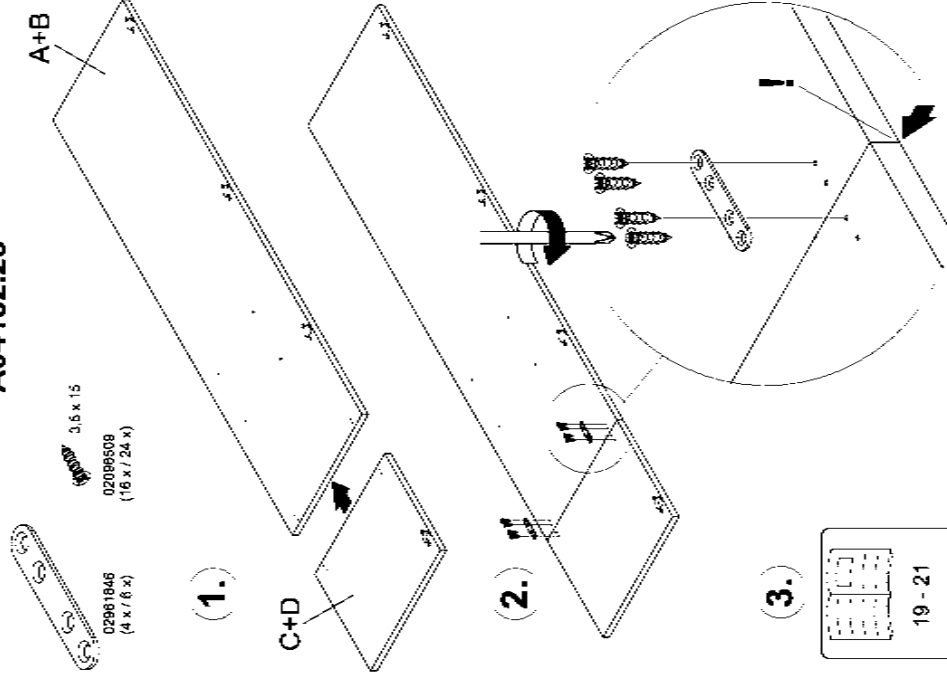
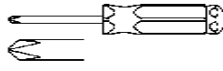

b x 30

02960364
(8 x / 12 x)

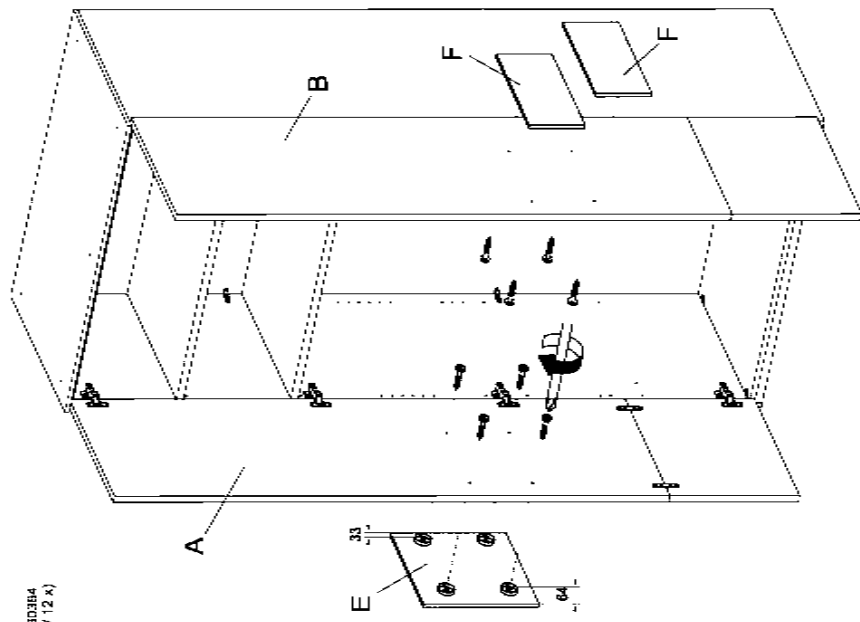

röhr

Montageanleitung
A04182.25

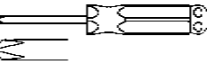
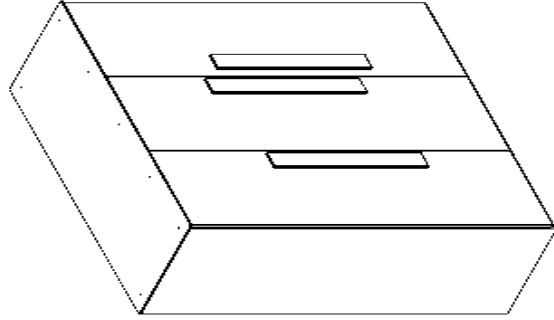

Beschlügen können aufgrund von standardisierten Produktionsprozessen einen Überschuss an Beschlügen enthalten.
In some of fittings maybe higher than listed because of universal fitting "schlegel".

röhr

Montageanleitung
A04182.26

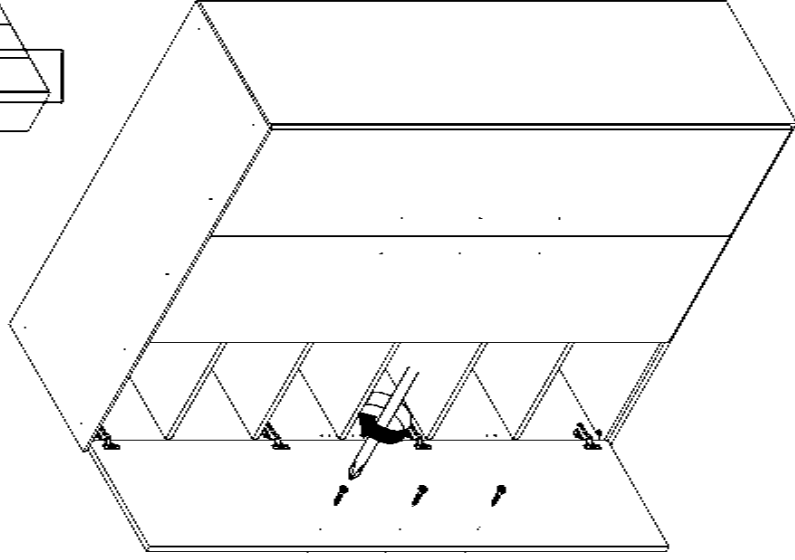
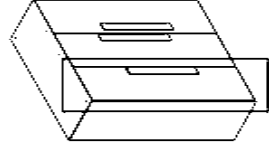

röhr

Montageanleitung
A04182.27

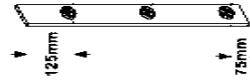
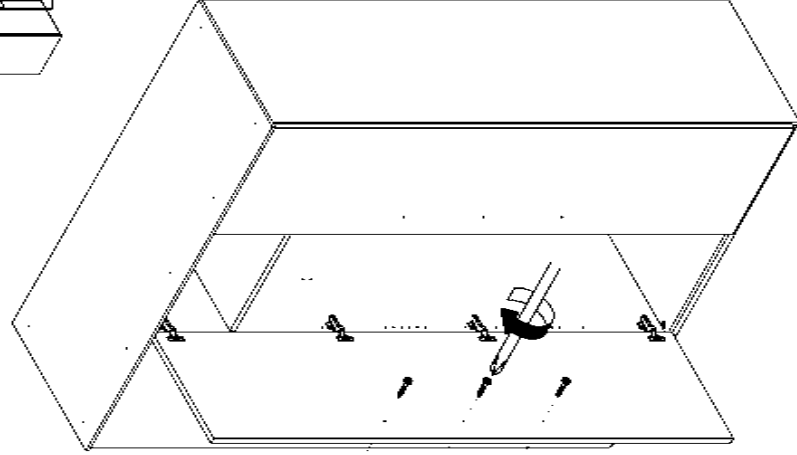
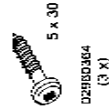
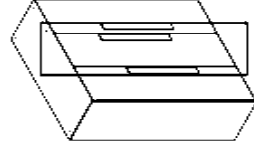

röhr

Montageanleitung
A04182.28

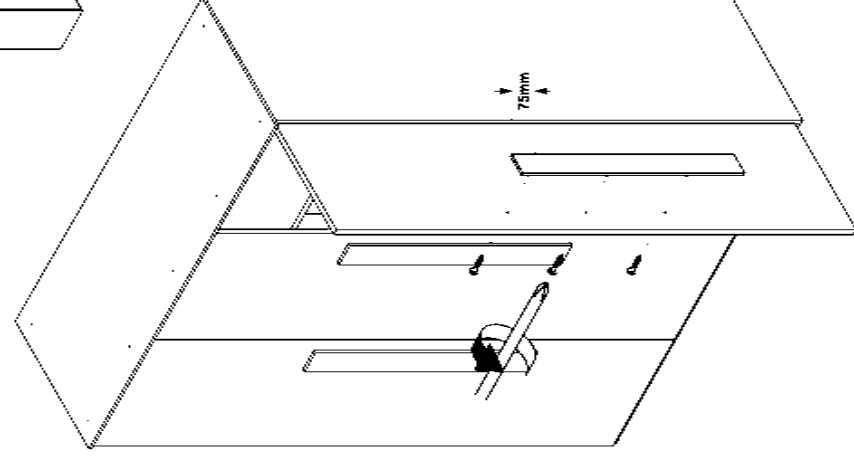
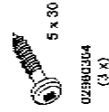
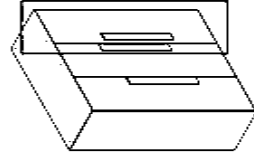

röhr

Röhr-Rush GmbH & Co. KG
 Dammstraße 32
 33397 Knetberg
 Germany
 Fon: +49 (0) 2944 981 198
 Fax: +49 (0) 2944 981 310

Montageanleitung A04185.01

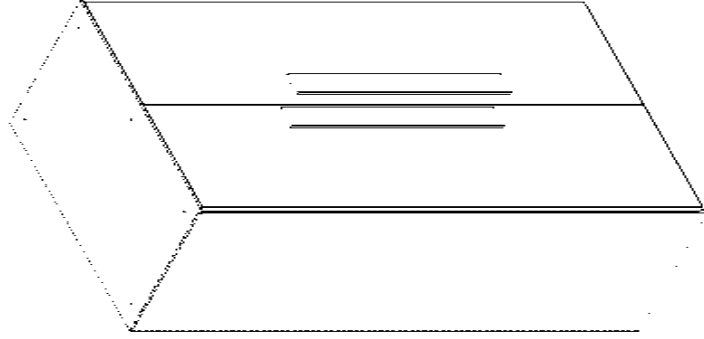

Bitte unbedingt lesen: Bei Nichtbeachtung können wir keine Gewährleistung übernehmen!
 Bitte bewahren Sie diese Montageanleitung für die Produkturückholung (Produktsicherheitsgesetz) und für event. spätere Rückfragen (wie z.B. Demontage) auf.
**Bei Weitergabe bzw. Übergabe des Artikels übernehmen Sie auch diese Montageanweisung.
 Attention!** It is essential to read this, in case of non-compliance, we can not accept any liability.
 Please retain these assembly instructions for product identification and all future references, i.e. disassembling.

With all transfers or deliveries of this item these assembly instructions should always be forwarded.
 D060619

röhr

Montageanleitung A04185.02

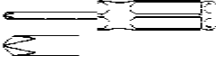
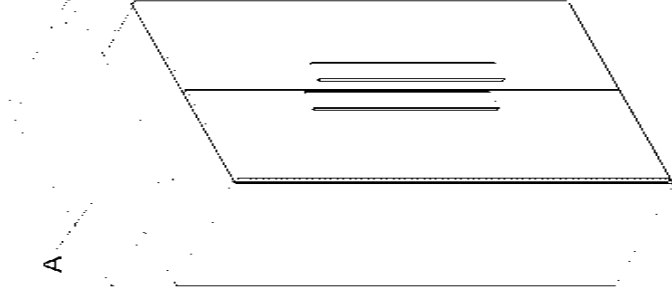

Beschädigten können aufgrund von standardisierten Produktionsprozessen einen Überschuss an Beschädigten (Number of Entries maybe higher than listed because of universal fitting-Principle)

röhr

Montageanleitung A04185.03

