

röhr

Röhr-Rush GmbH & Co. KG
 Dammstraße 32
 33397 Knetberg
 Germany
 Fon: +49 (0) 2944 981 198
 Fax: +49 (0) 2944 981 310

Montageanleitung A04185.01

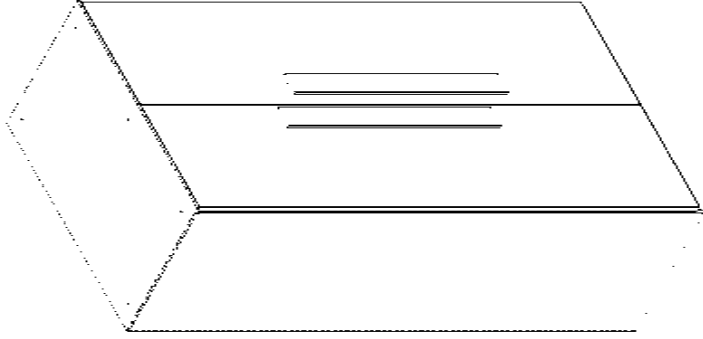

Bitte unbedingt lesen: Bei Nichtbeachtung können wir keine Gewährleistung übernehmen!
 Bitte bewahren Sie diese Montageanleitung für die Produkturkennung (Produktsicherheitsgesetz) und für event. spätere Rückfragen (wie z.B. Demontage) auf.
 Bei Weitergabe bzw. Übergabe des Artikels übernehmen Sie auch diese Montageanweisung.
 Attention! It is essential to read this. In case of non-compliance, we can not accept any liability.
 Please retain these assembly instructions for product identification and all future references i.e. disassembly.

With all transfers or deliveries of this item these assembly instructions should always be forwarded.
 D060619

röhr

Montageanleitung A04185.02

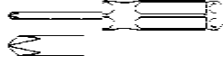
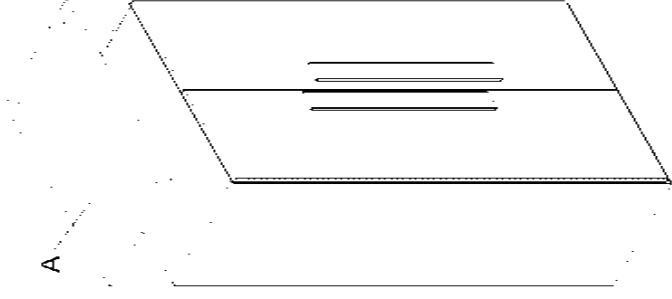

Beschädigungen können aufgrund von unrichtigen Produktionsprozessen einen Überschuss an Beschädigten verursachen.
 Damage of articles might happen from later because of uncorrected 'filling' packages!

röhr

Montageanleitung A04185.03

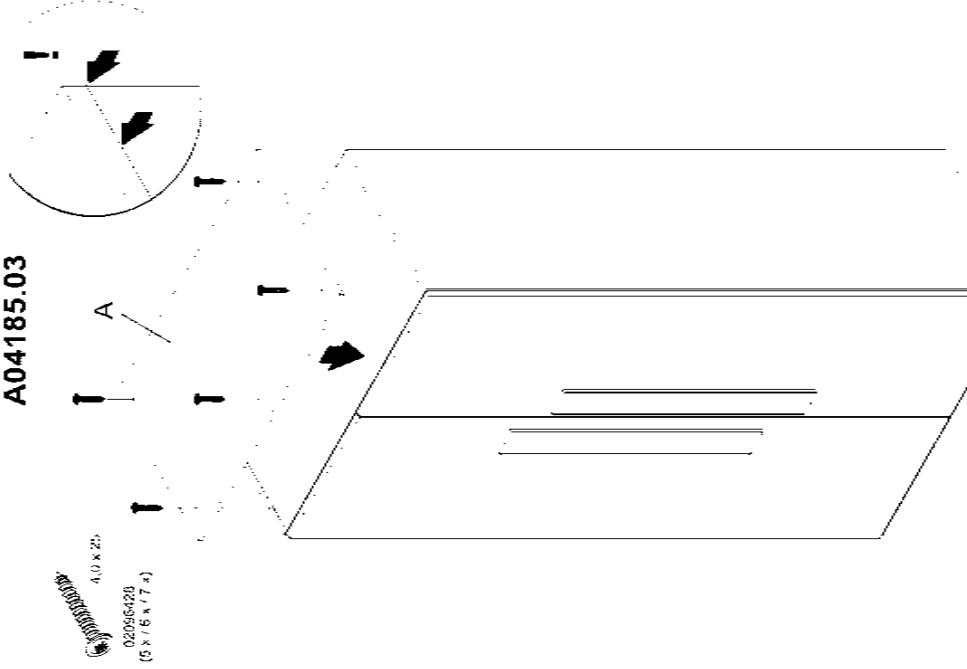

Röhr-Bush GmbH & Co. KG
Dammstraße 32
33397 Rietberg
Germany
Fon +49 (0) 2944 981 198
Fax +49 (0) 2944 981 310

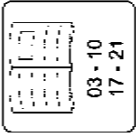

03 - 10
17 - 21

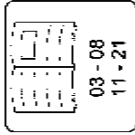
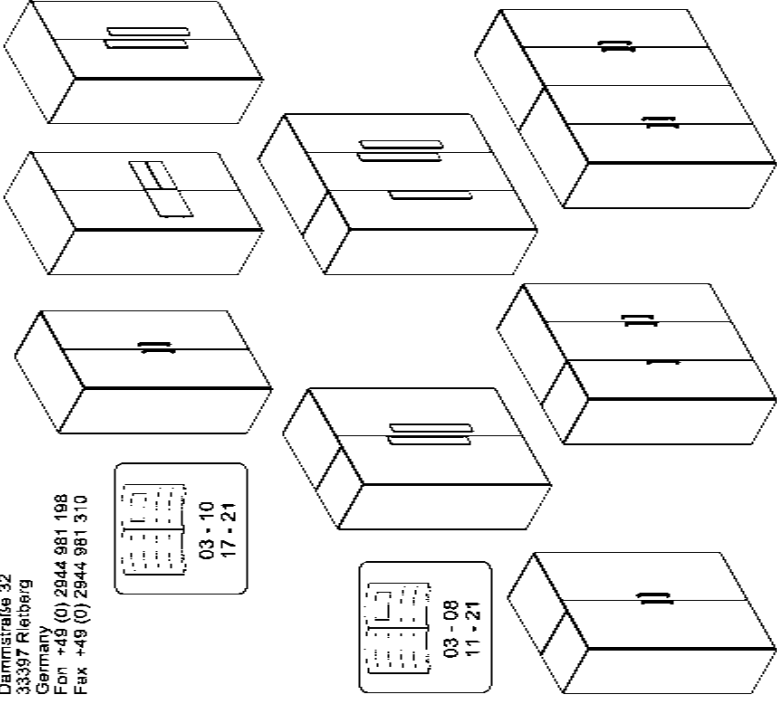

03 - 08
11 - 21

Bitte unbedingt lesen: Bei Nichtbeachtung können wir keine Gewährleistung übernehmen!
Bitte bewahren Sie diese Montageanleitung für die Produktkennzeichnung (Produktsicherheitsgesetz) und für evtl. spätere Rückfragen (wie z. B. Demontage) auf.
Bei Weitergabe bzw. Übergabe des Artikels übergeben Sie auch diese Montageanleitung.
Attention! It is essential to read this. In case of non-compliance we cannot accept any liability.
Please retain this assembly instruction for product identification and all future references e.g. disassembly.

With all transfers or deliveries of this item this assembly instruction should always be forwarded.

0091020

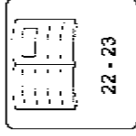

22 - 23

geteilte Türen
two part doors

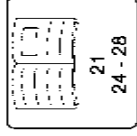
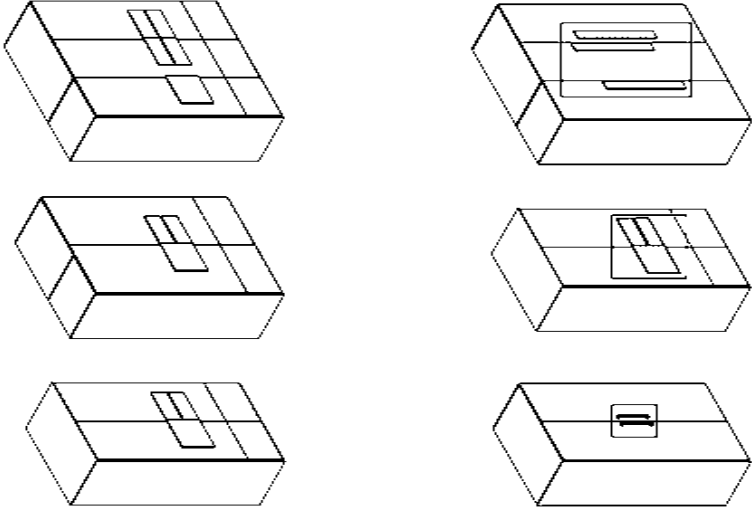

21
24 - 28

Griffe
handles

02 096098		02 096079		02 096030	
02 096530		02 096420		02 097108	
02 066508		02 096232		02 096449	
02 096489		02 9E3279		02 9E3279	
Geteilte Türen two part doors		02 9E1946		02 096469	
				02 9E3284	

Griffe variieren in
Form und Position
in den Programmier-
Bezeichnungen können sich
Produktionsprozesse eines
Beschäftigten enthalten!
The content of fittings may
be different because of
universal fitting packages!

Position and Design of
Handles can be
different from shown!

Bezeichnungen können sich
Produktionsprozesse eines
Beschäftigten enthalten!
The content of fittings may
be different because of
universal fitting packages!

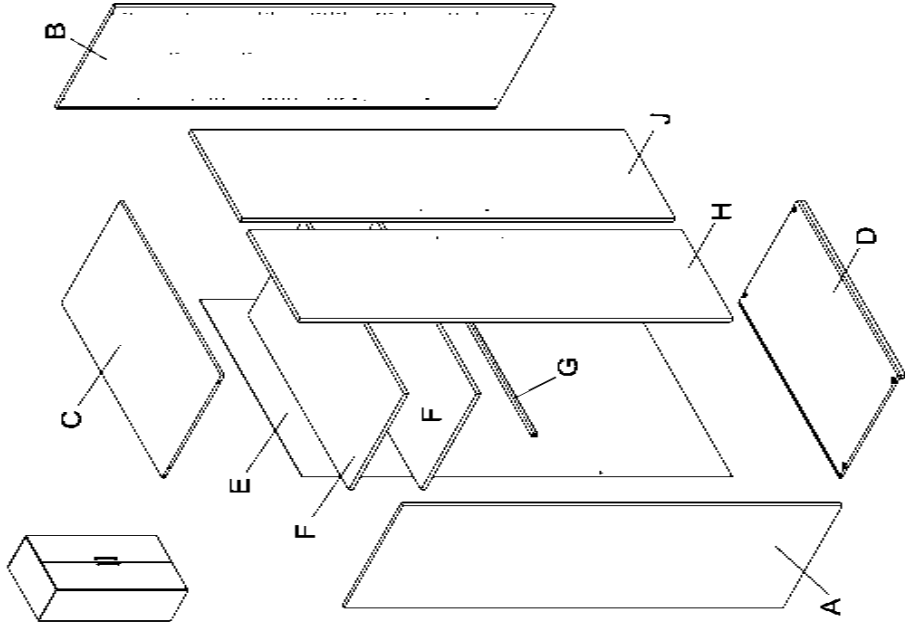
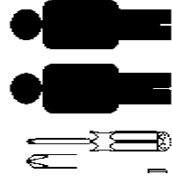

röhr

Montageanleitung
A04182.05

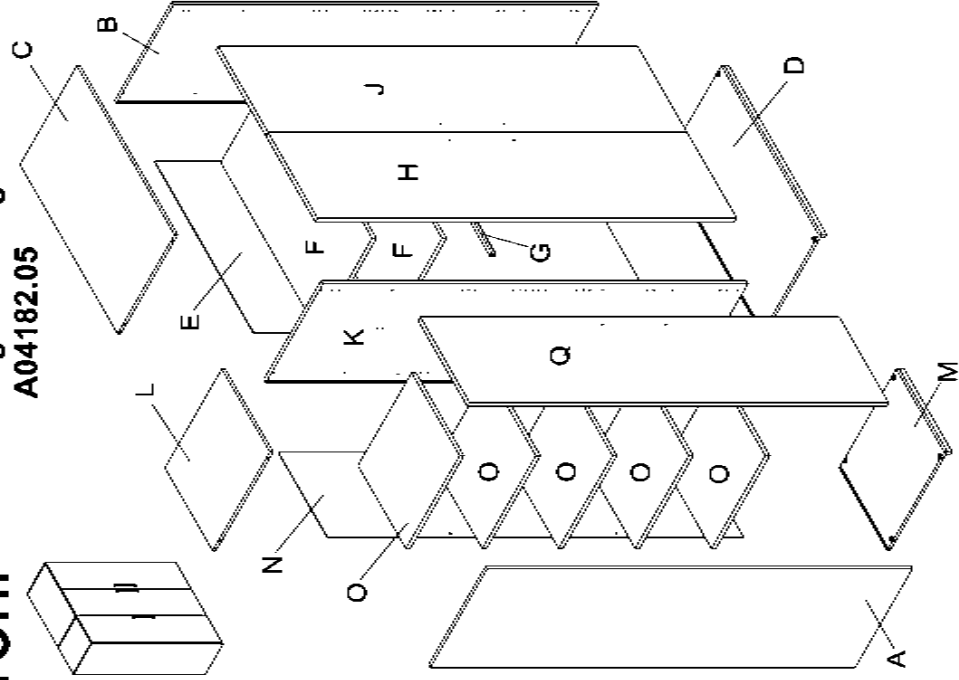
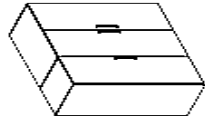

röhr

Montageanleitung
A04182.06



02096088
(2 X)

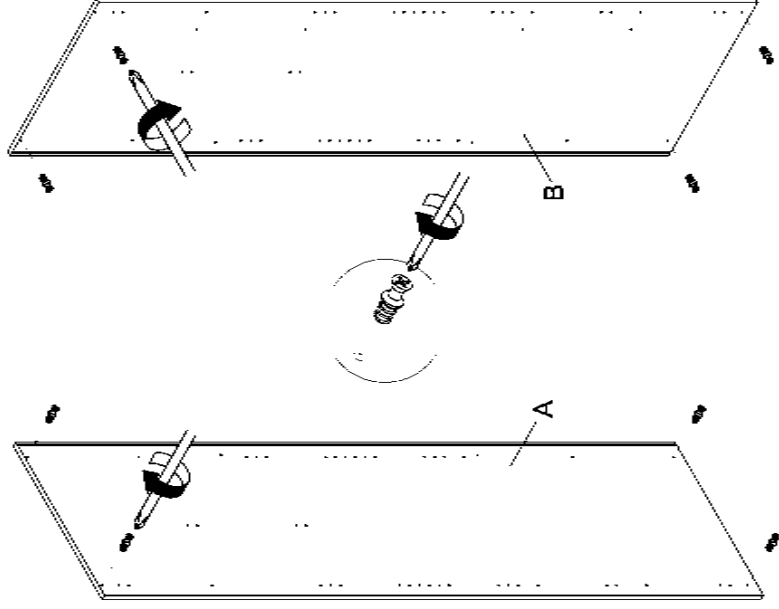

röhr

Montageanleitung
A04182.07

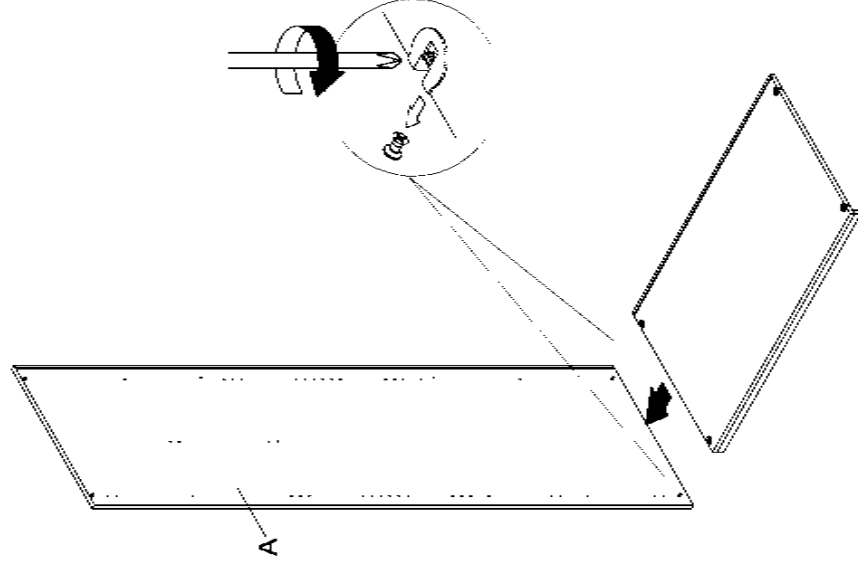

röhr

Montageanleitung
A04182.08



02096039
(2 X)



02096530
(2 X)

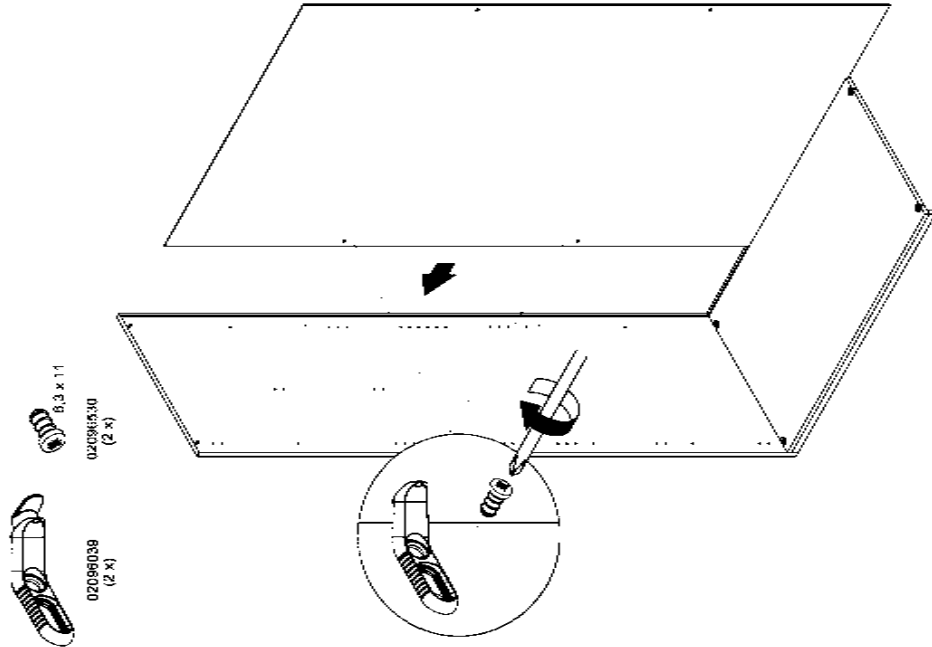

röhr

Montageanleitung
A04182.09

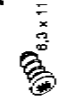
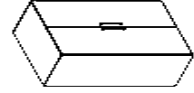

02098039
(2 X)



02098530
(2 X)

2.

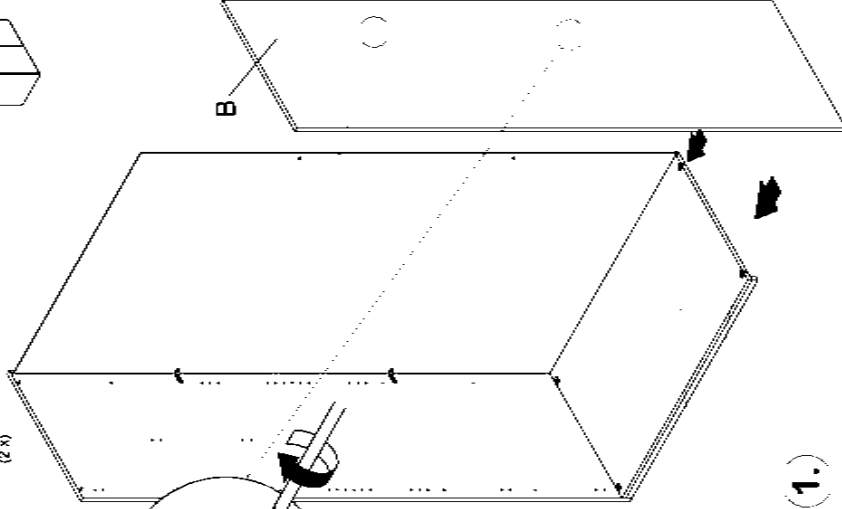
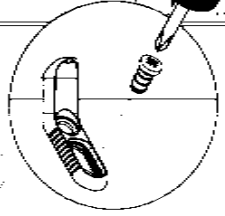

1.

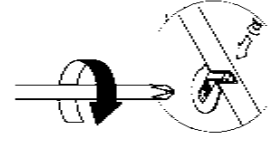

Montageanleitung
A04182.10

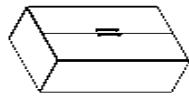

C

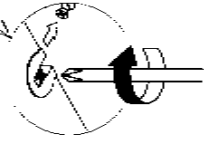
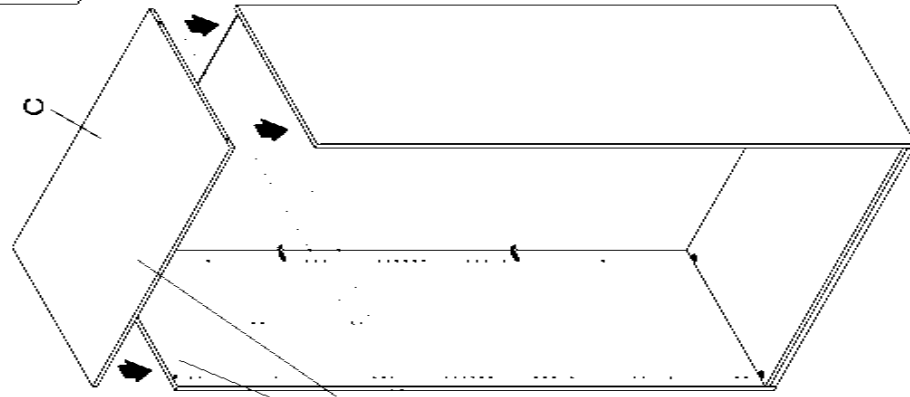

röhr

Montageanleitung
A04182.11

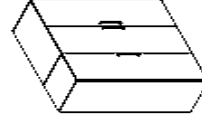

02086086
(6 X)

2.

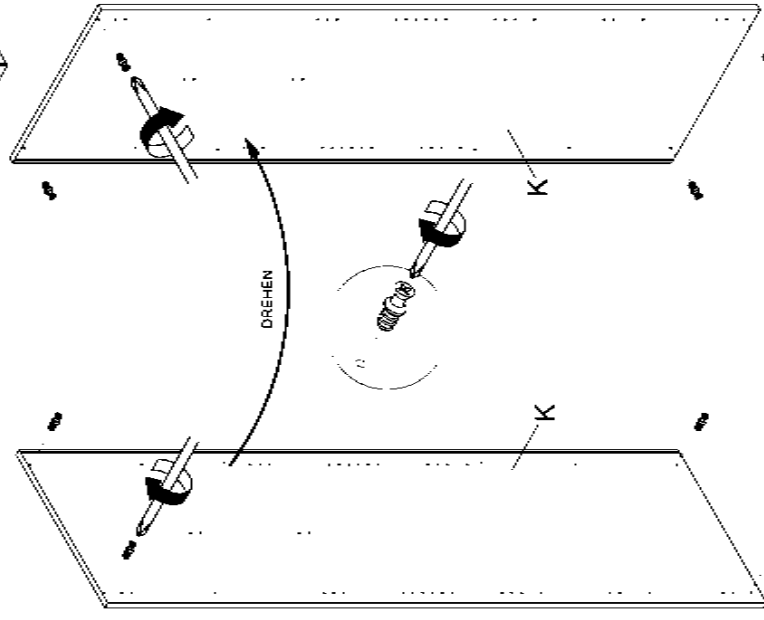
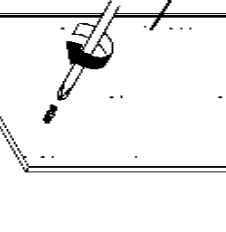

DREHEN

K

K

röhr

Montageanleitung
A04182.12

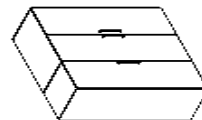

02098039
(2 X)

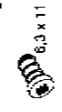

02098530
(2 X)

2.

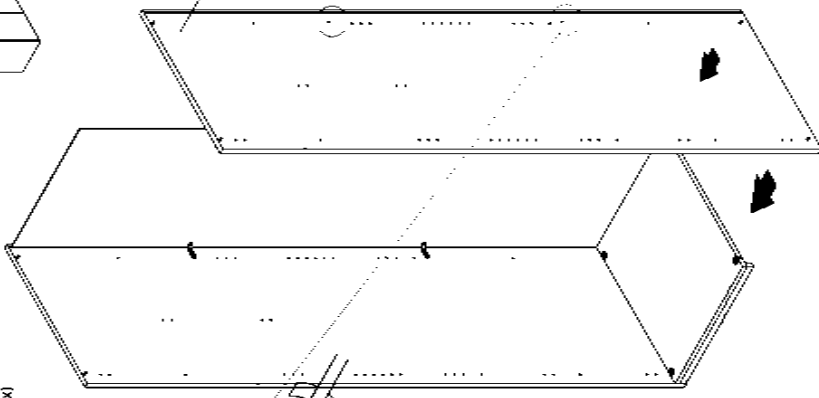
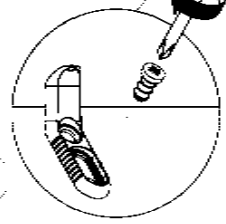

1.

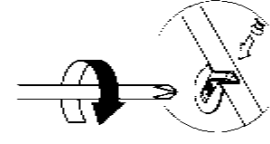

röhr

Montageanleitung
A04182.14

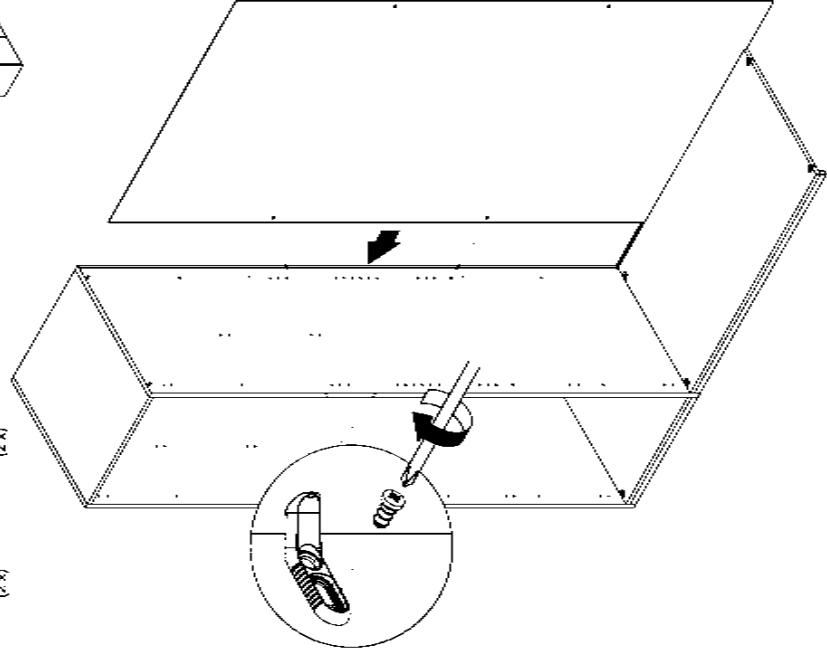
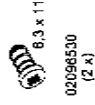

röhr

Montageanleitung
A04182.13

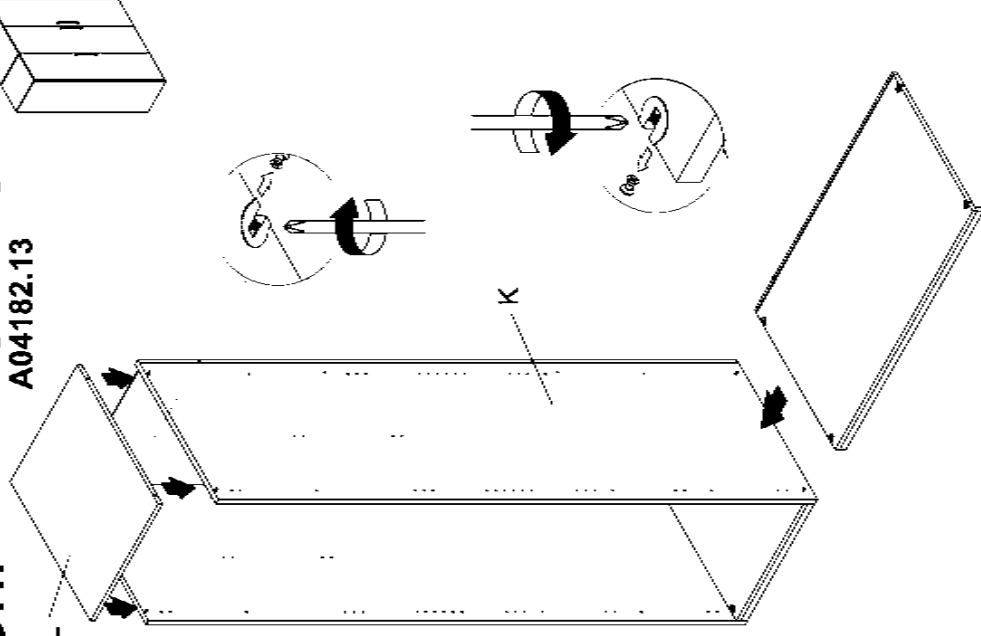
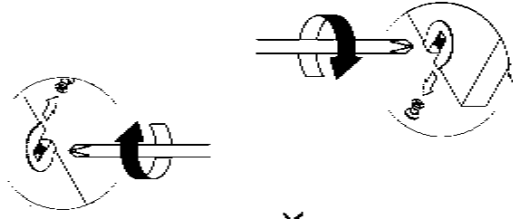

röhr

Montageanleitung
A04182.15

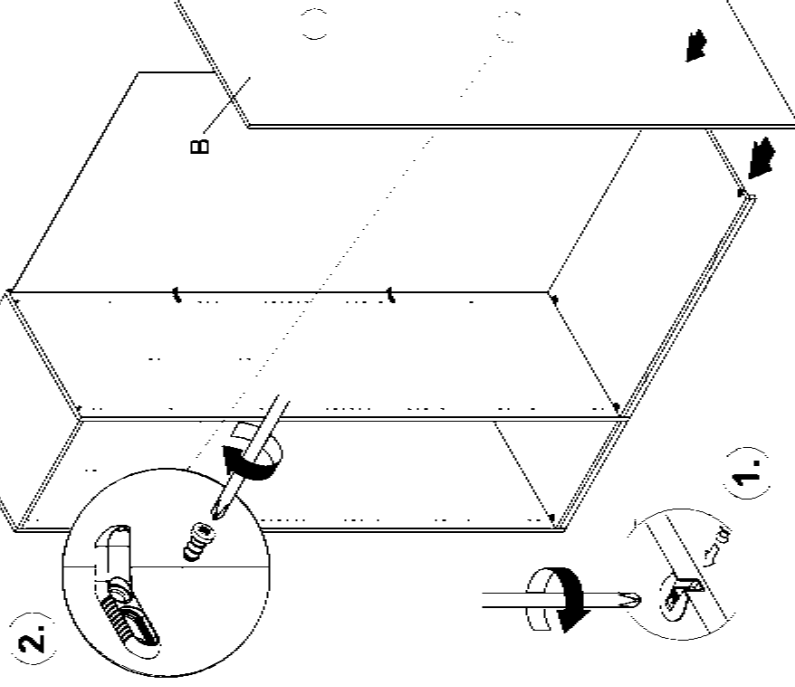
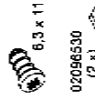
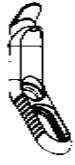

röhr

Montageanleitung
A04182.16

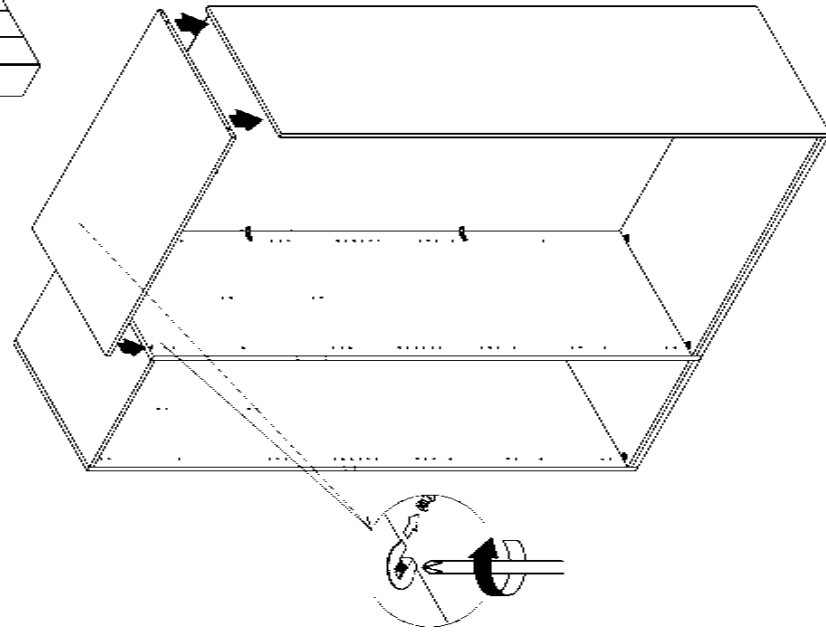

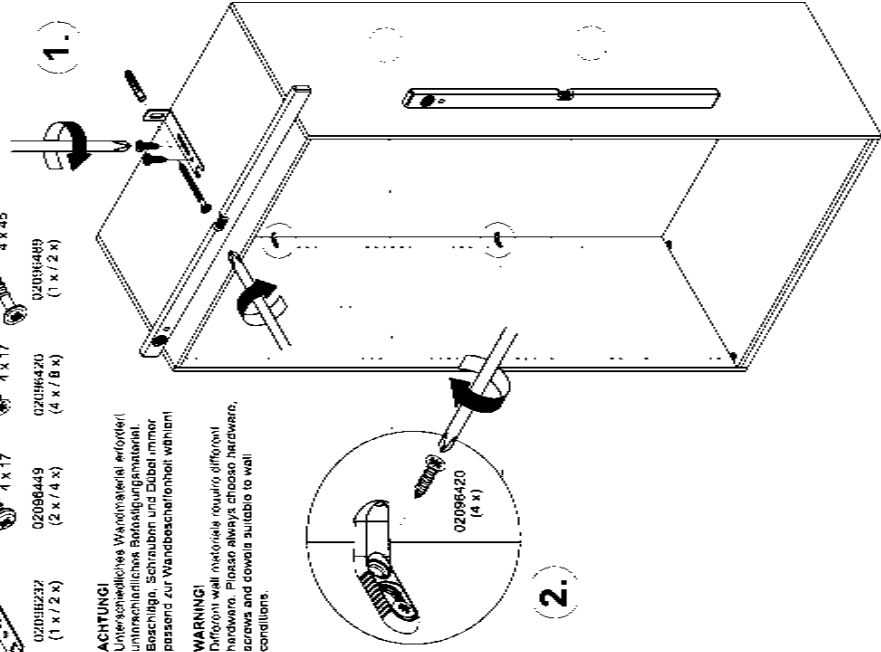
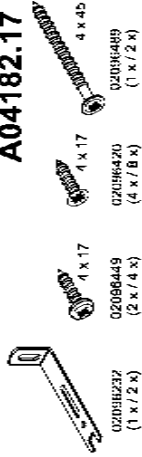
röhr**Montageanleitung
A04182.17**

ACHTUNG!
 Unter bestimmten Umständen ist die
 Unterseite des Türschwelles zu
 beschleifen. Schrauben und Dübel
 müssen für Wandbeschaffenheiten
 passen.

WARNING!
 Diffusion wall installation requires
 additional work under certain
 conditions. Screws and dowels
 must be suitable for wall
 conditions.

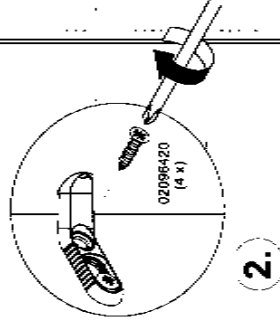
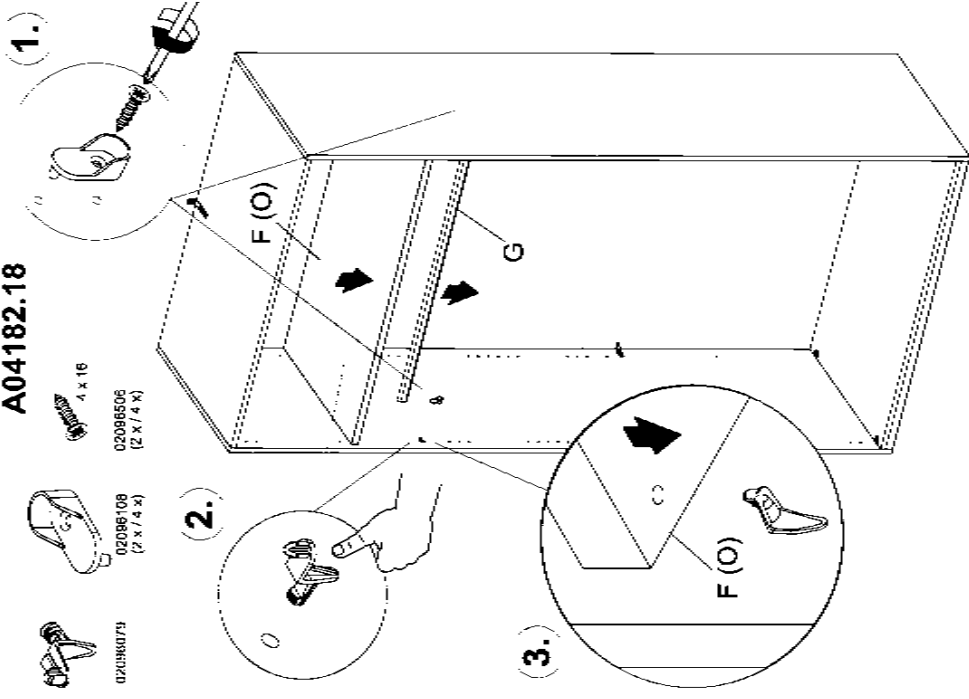
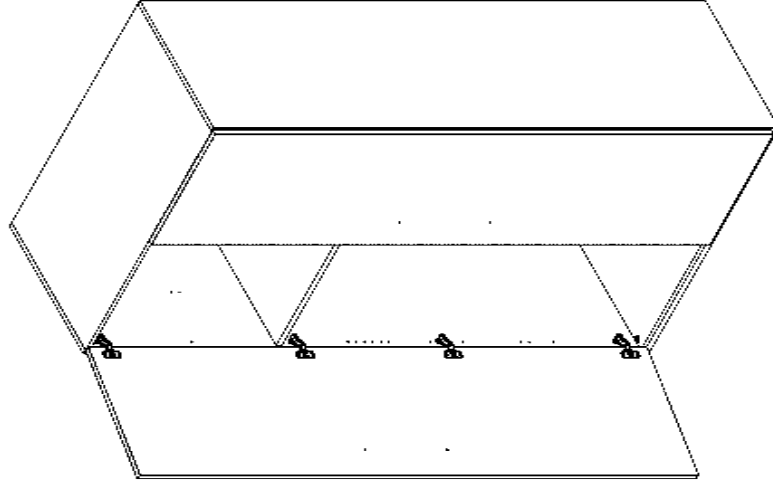
**röhr****Montageanleitung
A04182.18****röhr****Montageanleitung
A04182.19**

Montage / Assembly doors

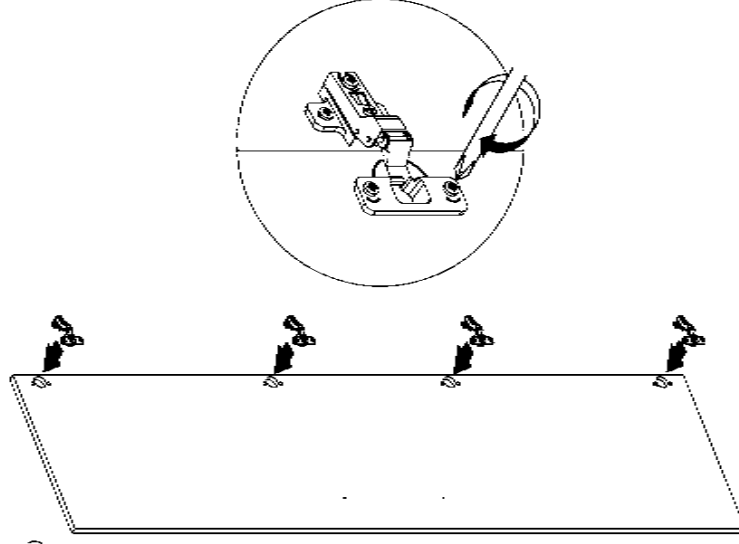
röhr**Montageanleitung
A04182.20**

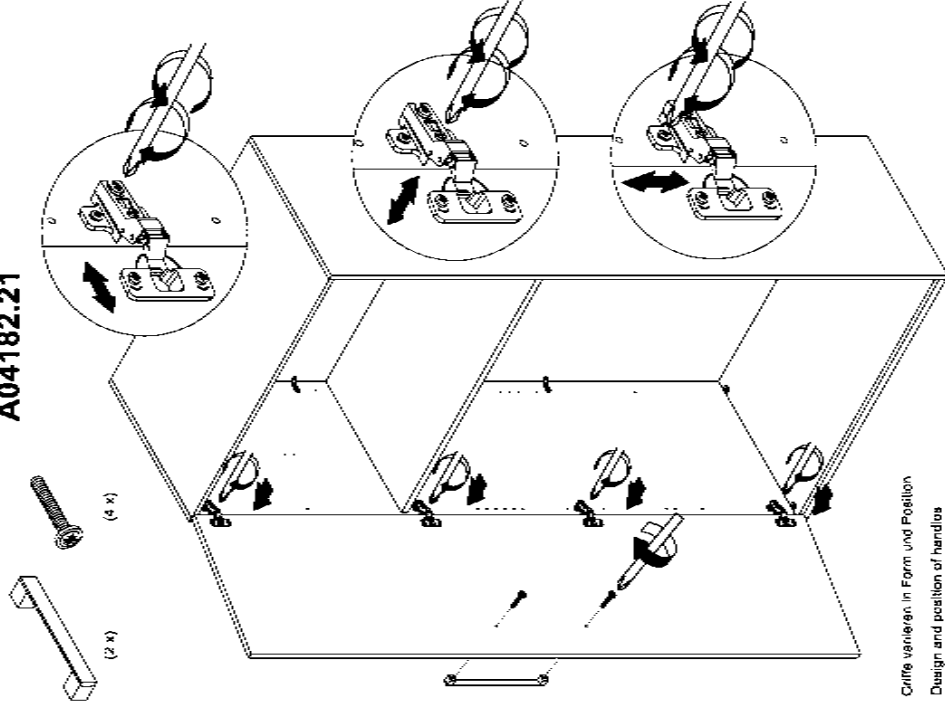

Größe variieren in Form und Position
Design and position of handles
can be different than shown

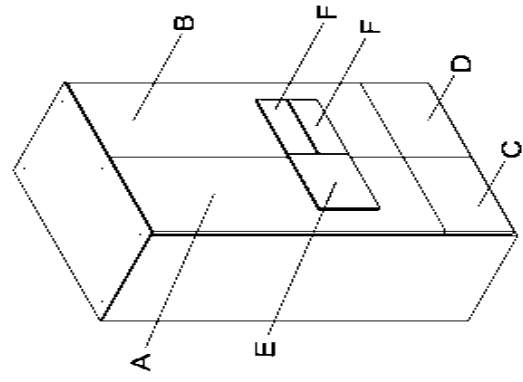

02960364



5 x 30

02961846

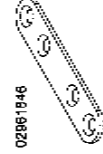

8 x 30

02096509



3,5 x 15

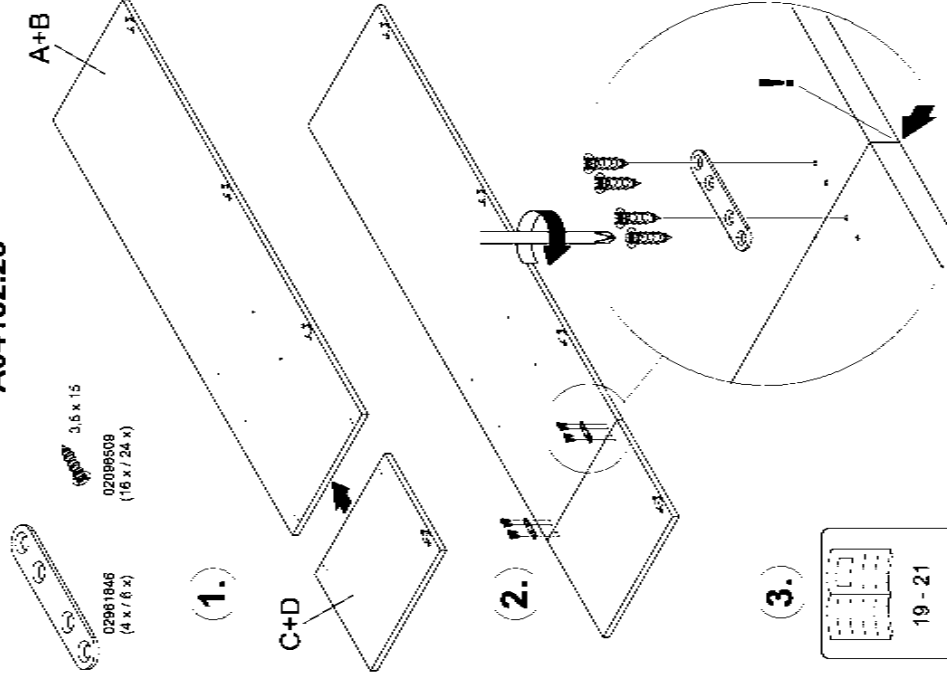
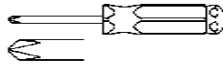

5 x 30

02960364
(8 x / 12 x)

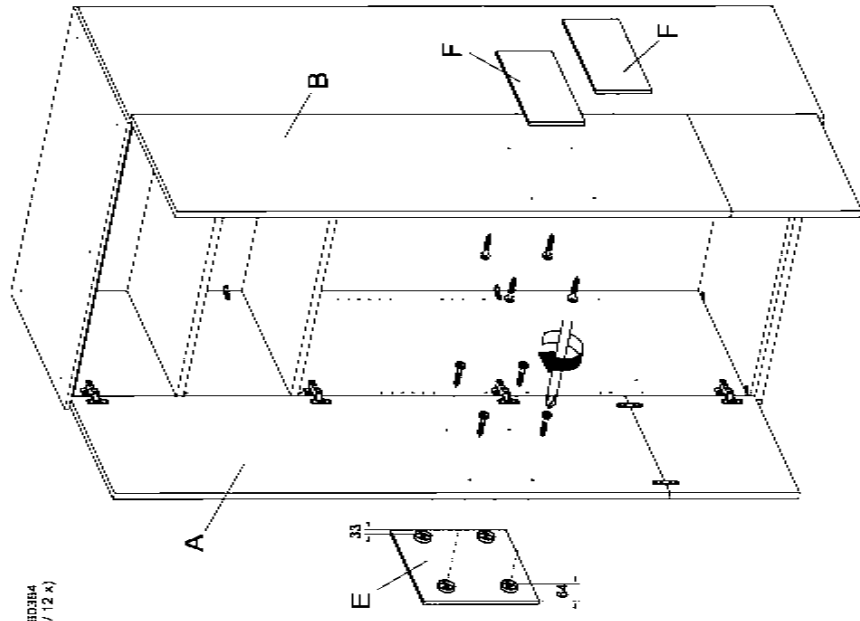

röhr

Montageanleitung
A04182.25

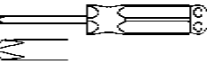
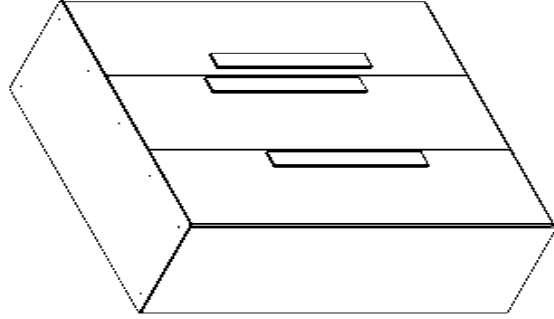

Beschlügen können aufgrund von standardisierten
Produktionsprozessen einen Überschuss an Beschlügen
enthalten.
In some of fittings maybe higher than listed because of
universal fitting "schlüssel".

röhr

Montageanleitung
A04182.26

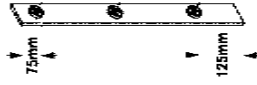
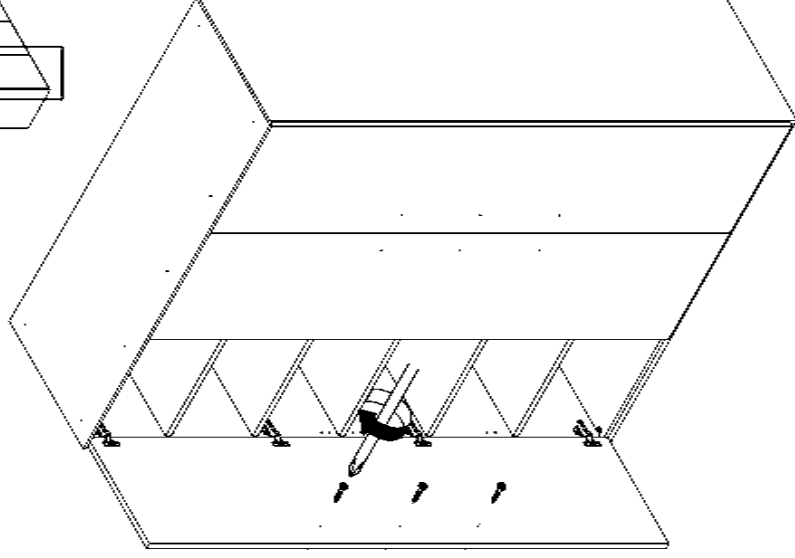
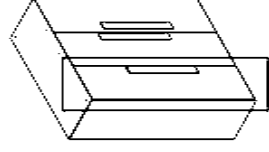

röhr

Montageanleitung
A04182.27

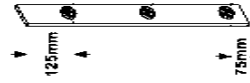
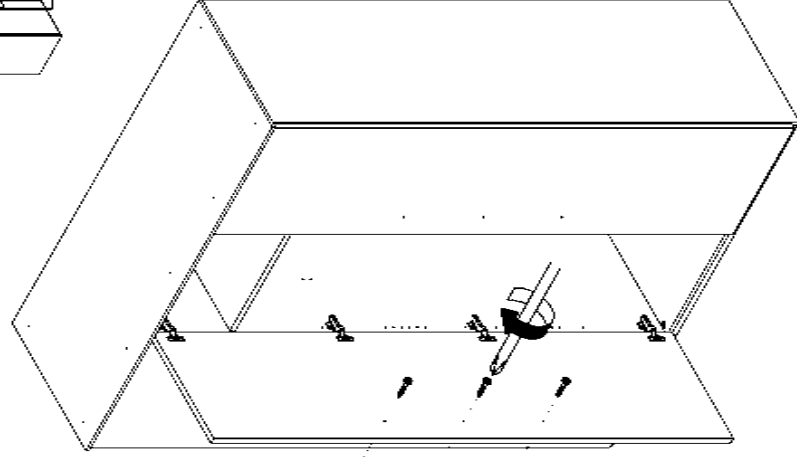
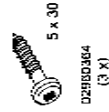
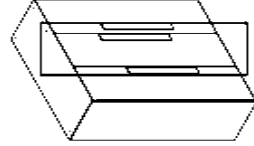

röhr

Montageanleitung
A04182.28

