

A	B	C1	C2	C3	D
1	M249-3003	799	280	32	1/1
2	M249-4301	1065	800	16	1/1
3	M249-5003	940	32	30	1/1
4	M249-5004	1065	65	22	1/1

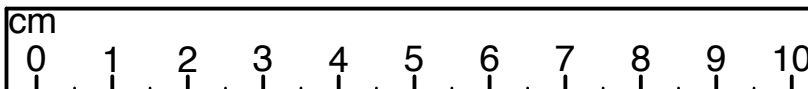
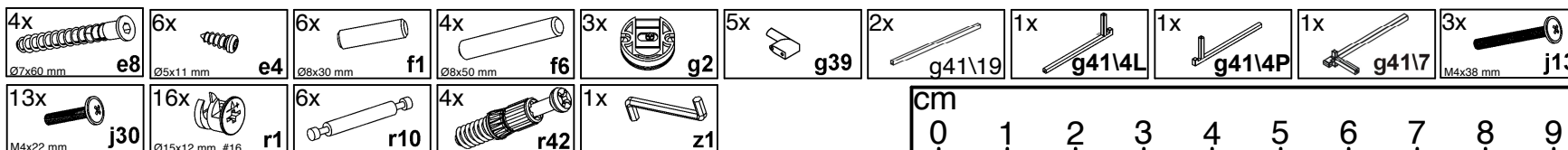
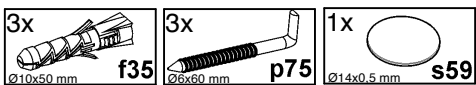
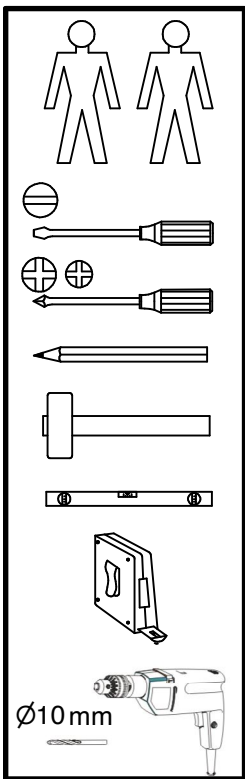
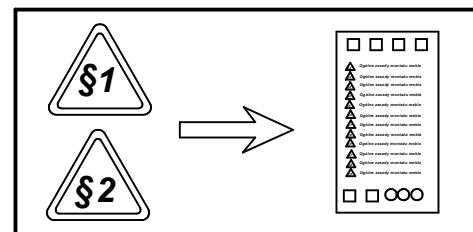
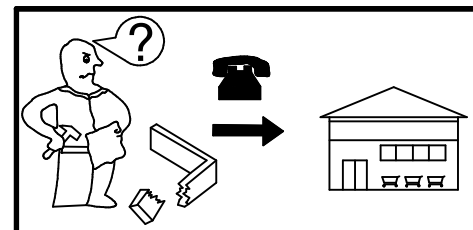
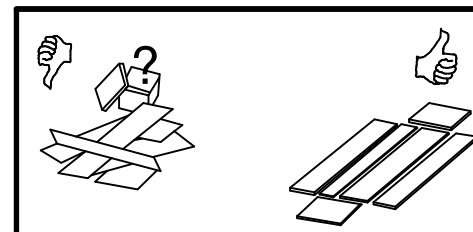
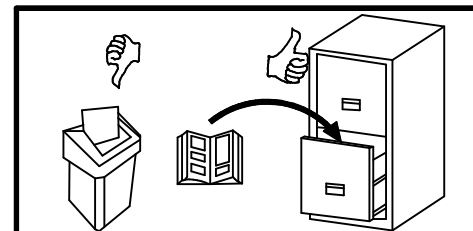
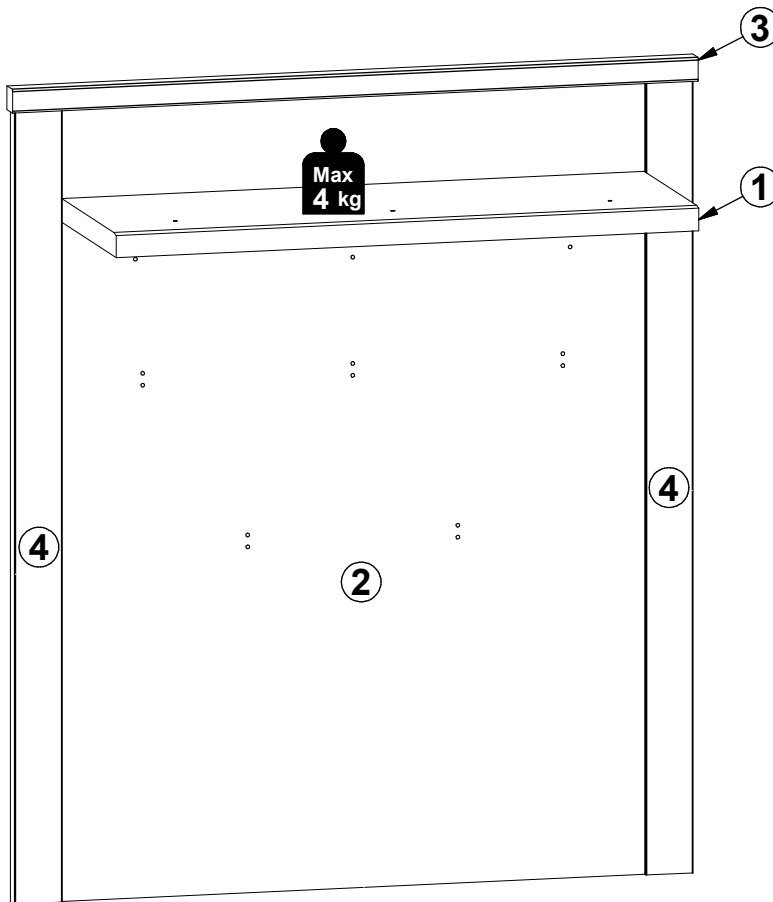
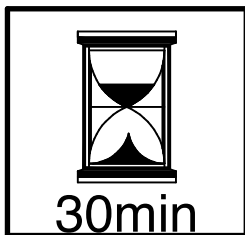
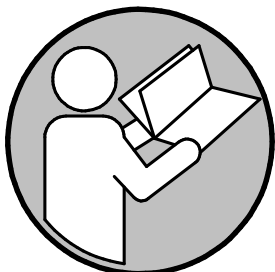
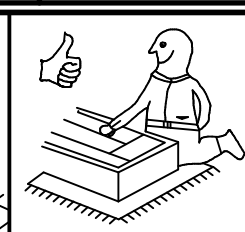
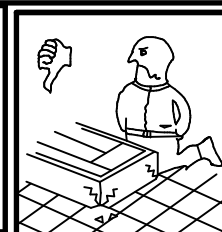
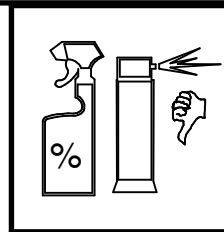

A

M249-PAN/11/9

3095--40

2 / 7

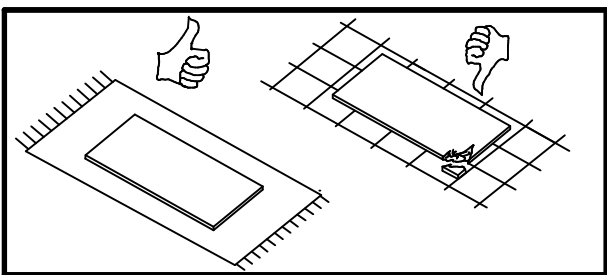
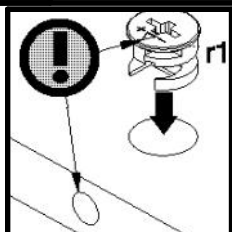

1

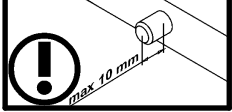
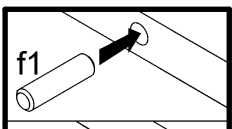
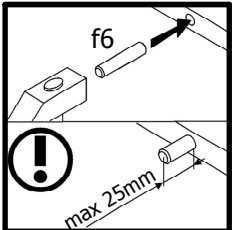
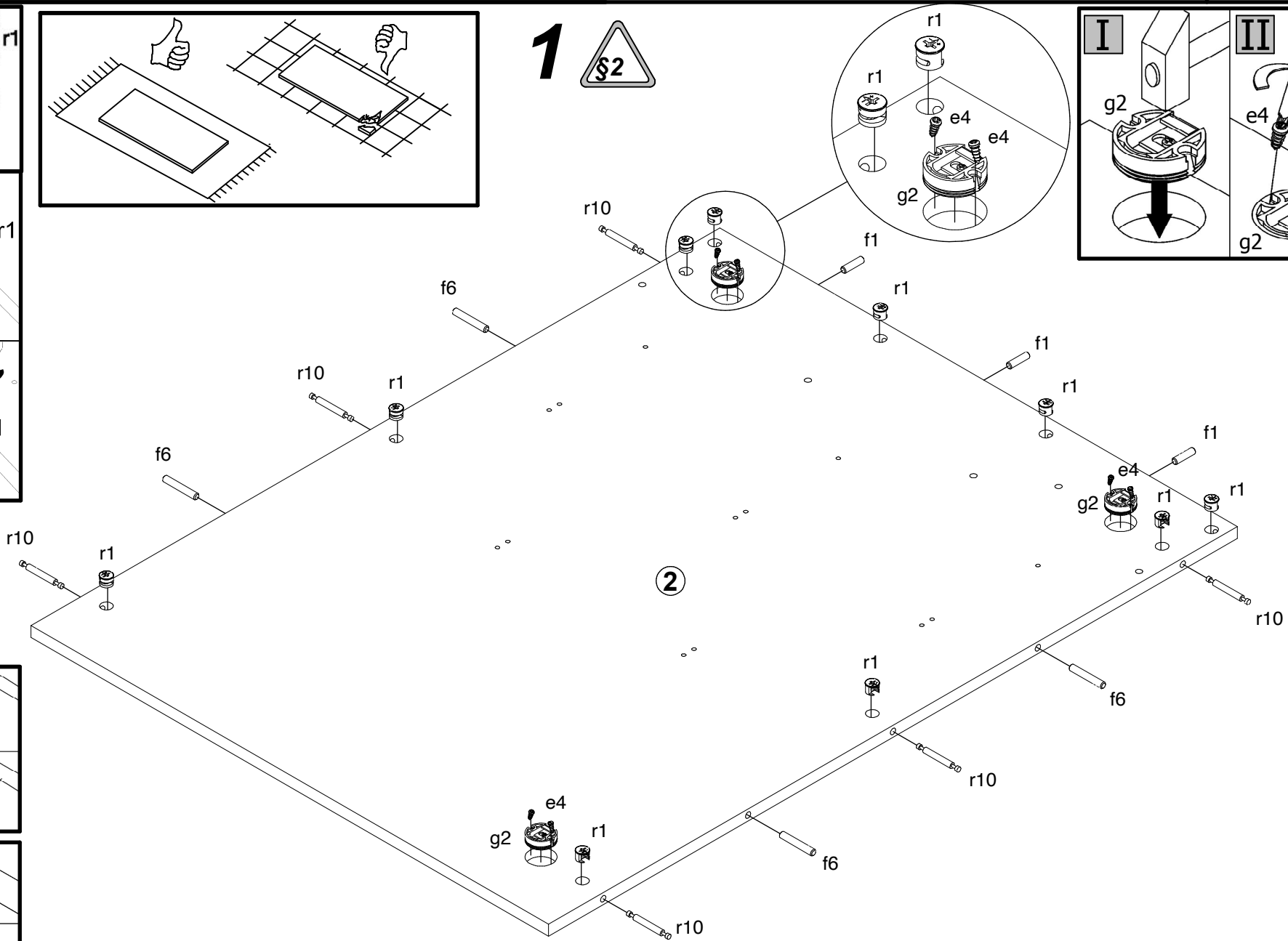
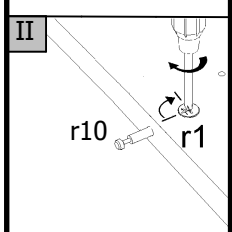
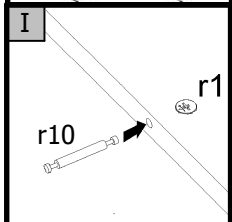
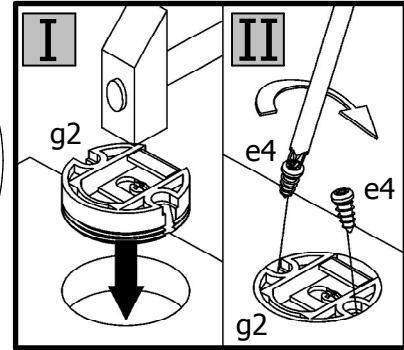

- 3x g2
- 6x e4
Ø5x11 mm
- 3x f1
Ø8x30 mm
- 4x f6
Ø8x50 mm
- 6x r10
- 10x r1
Ø15x12 mm #16

A

M249-PAN/11/9

3095--40

3 / 7

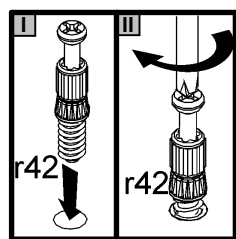
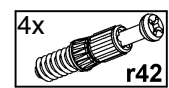
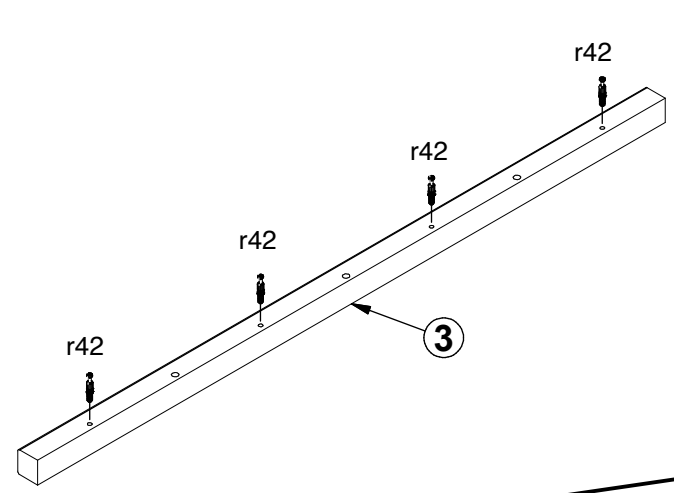
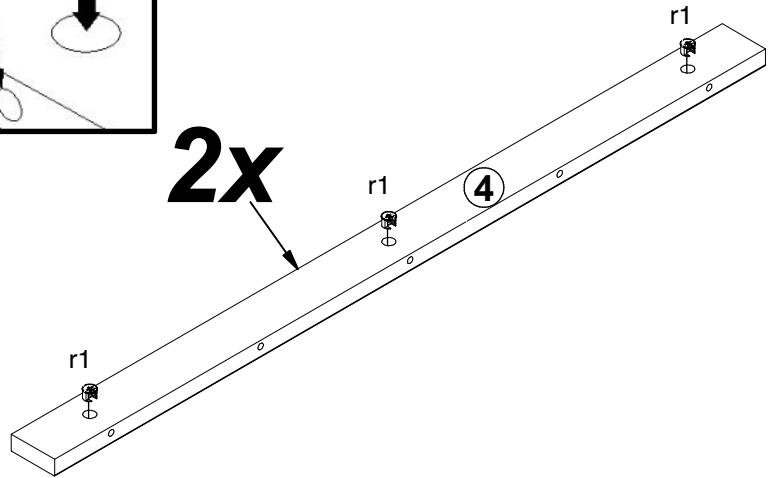
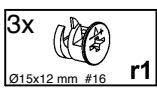
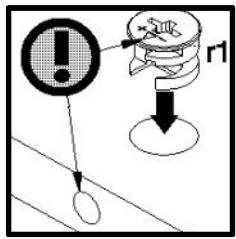

I

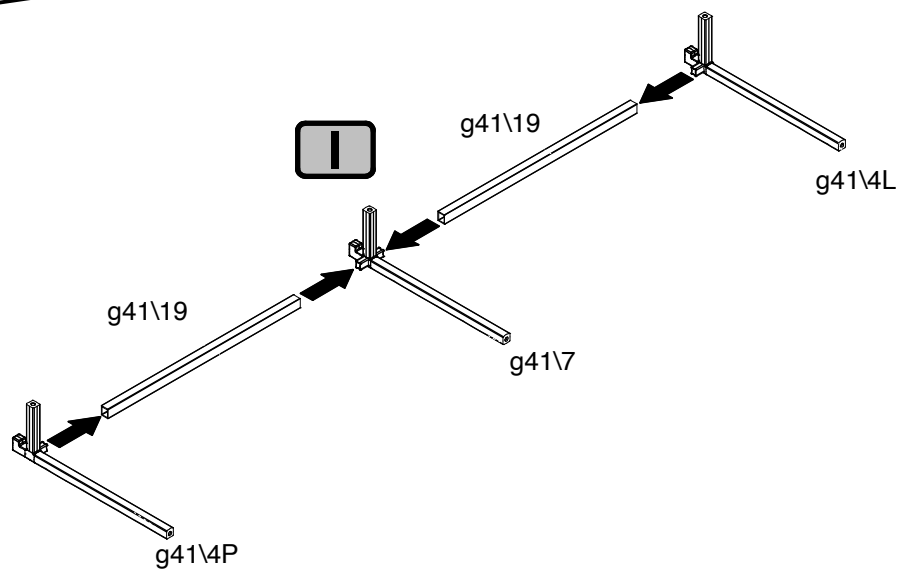

II

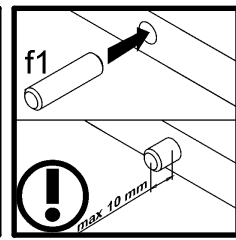
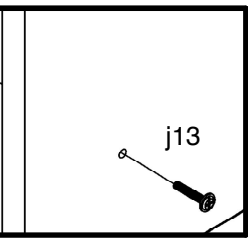
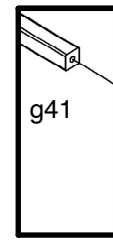
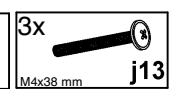
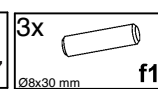
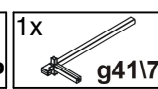
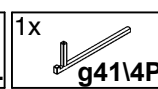
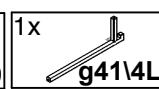
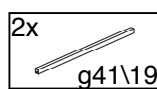
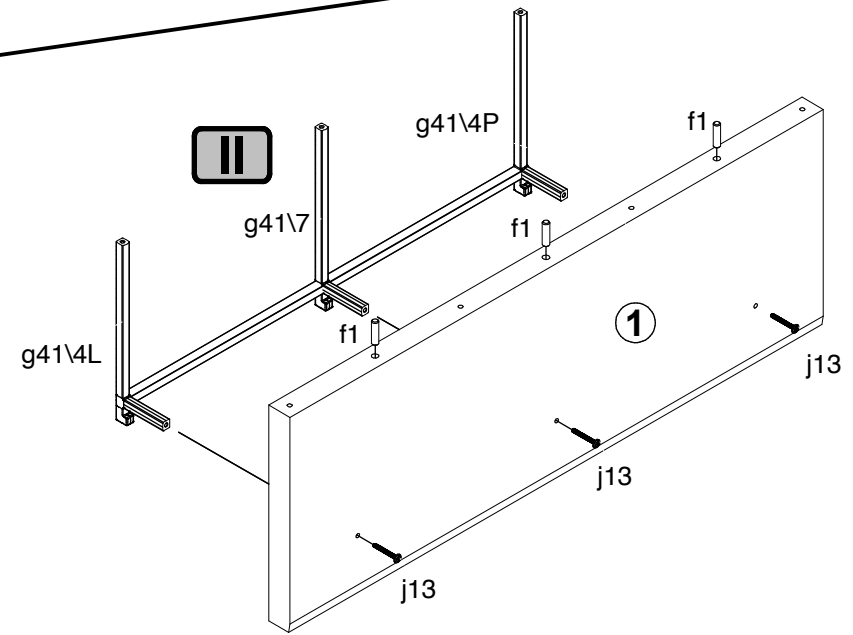

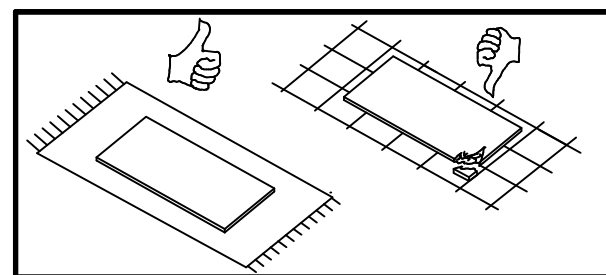
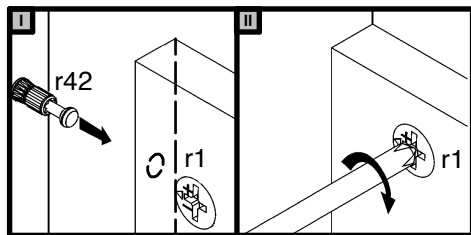

2

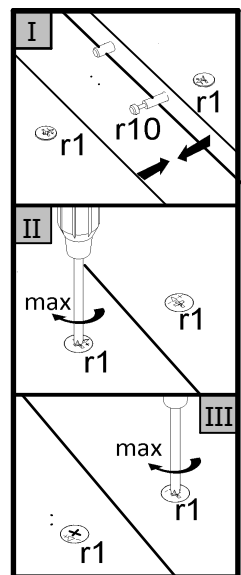
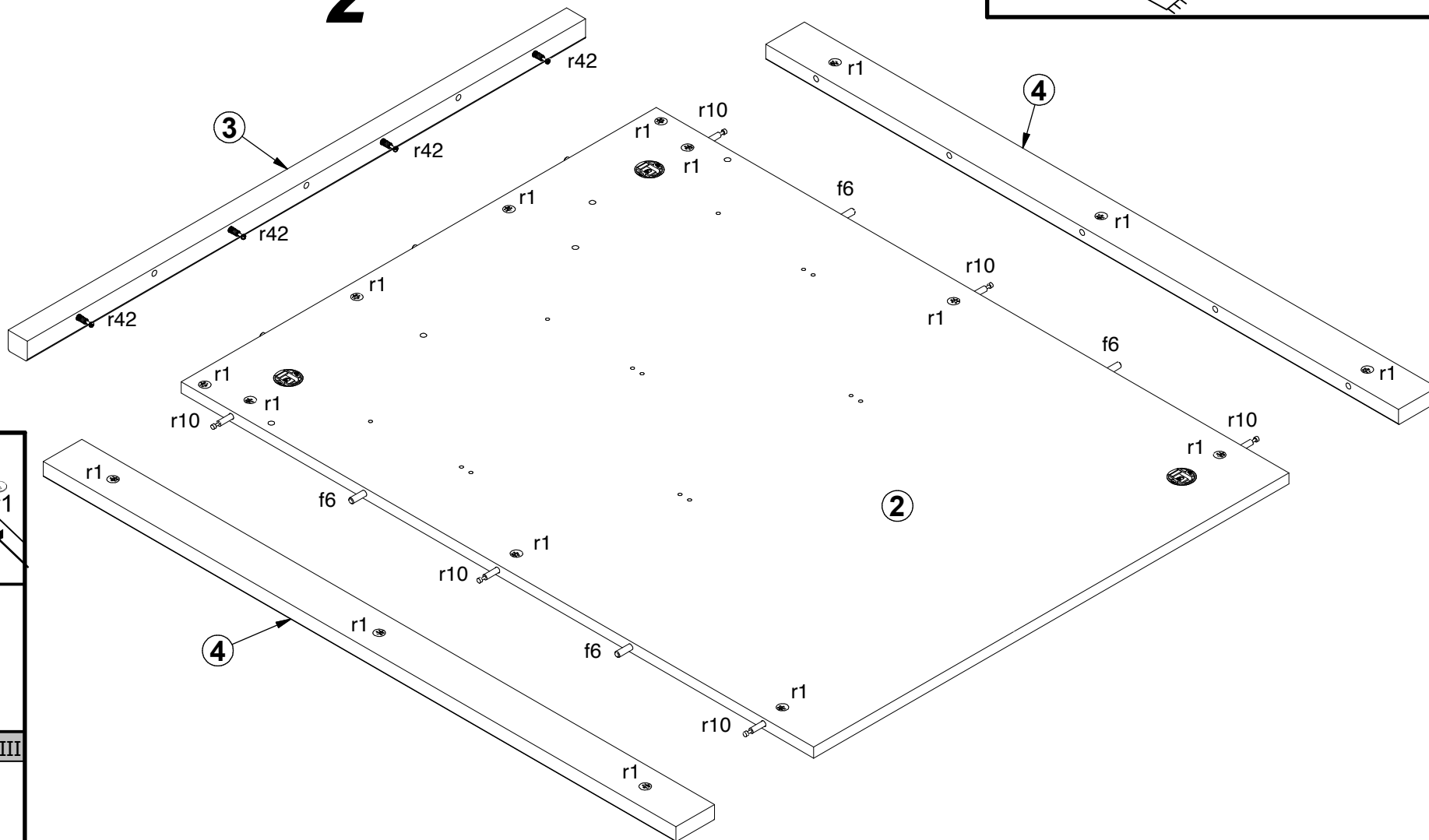

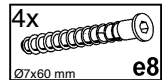
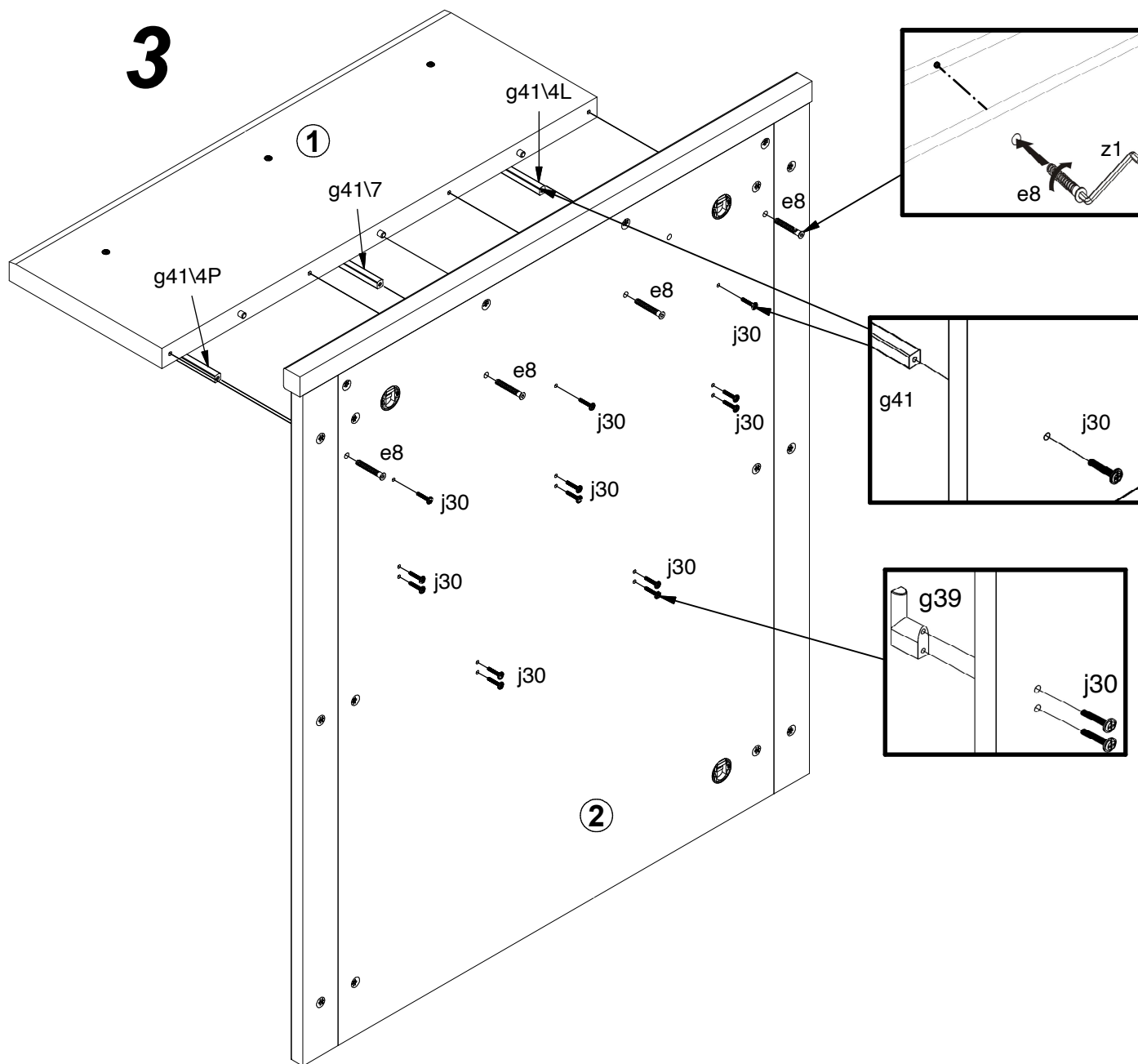

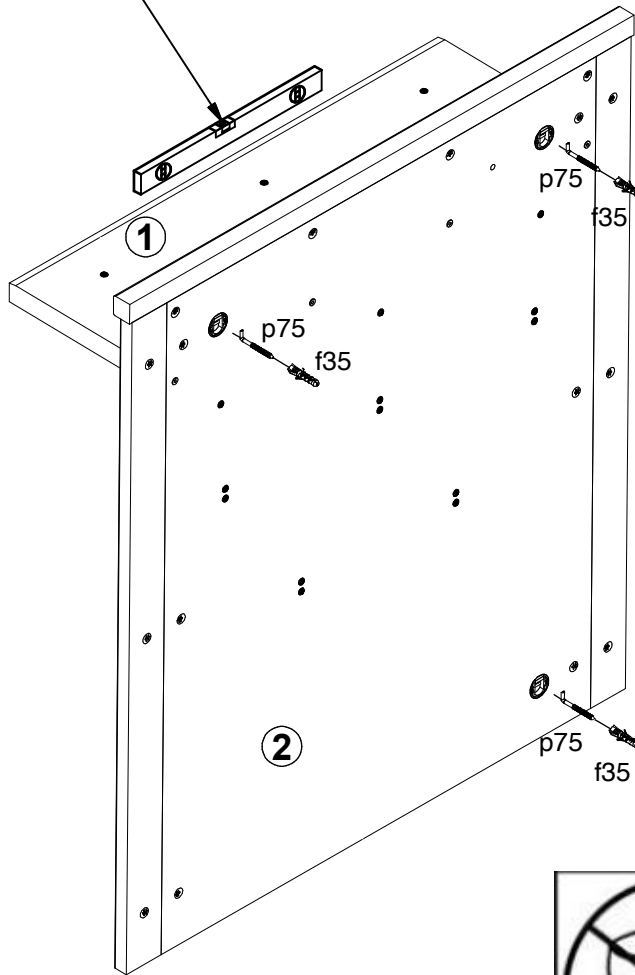
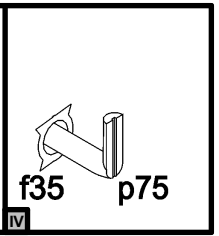
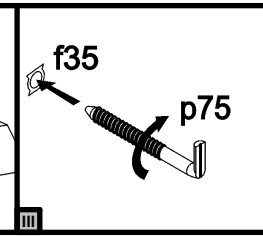
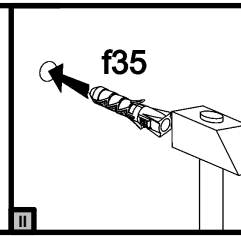
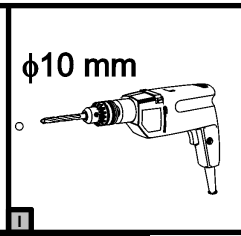
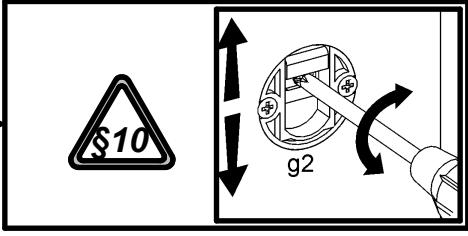
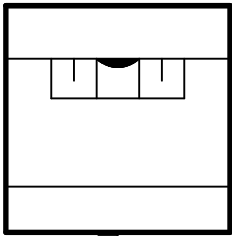

4

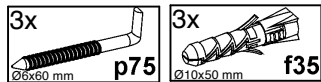
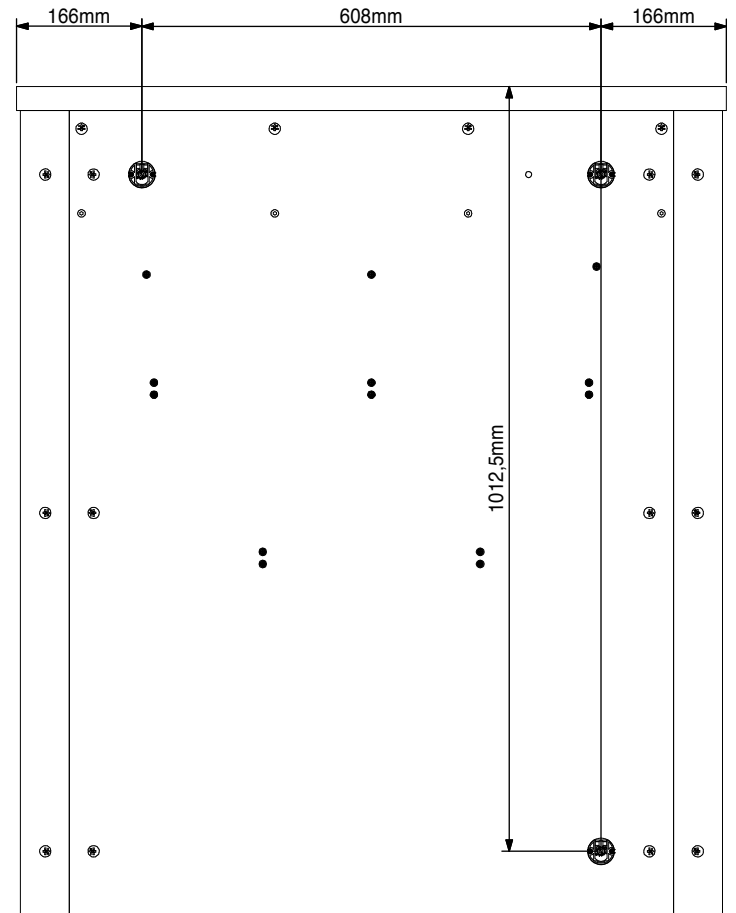
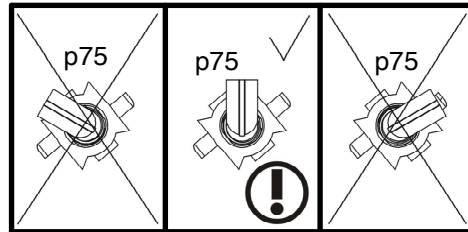
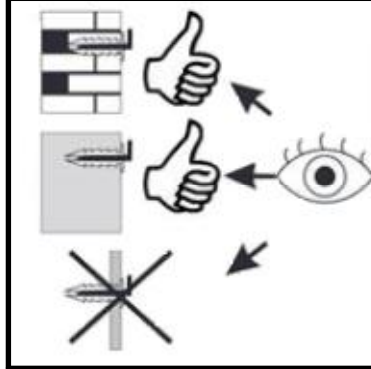

5

