

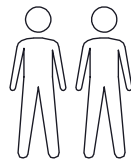

1 : 00

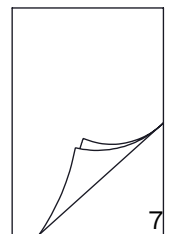

x 2

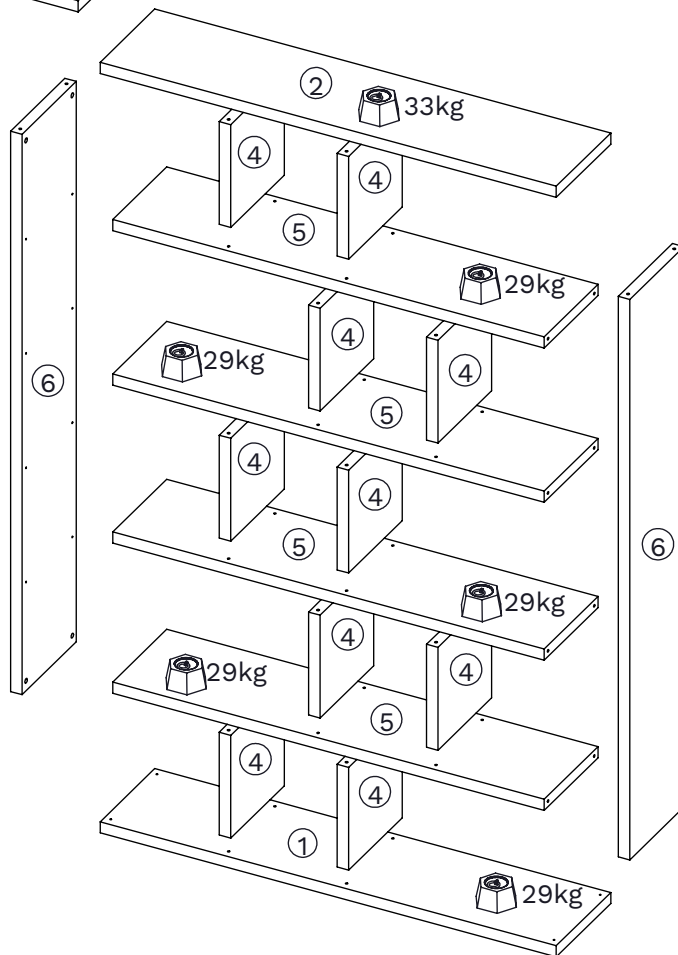
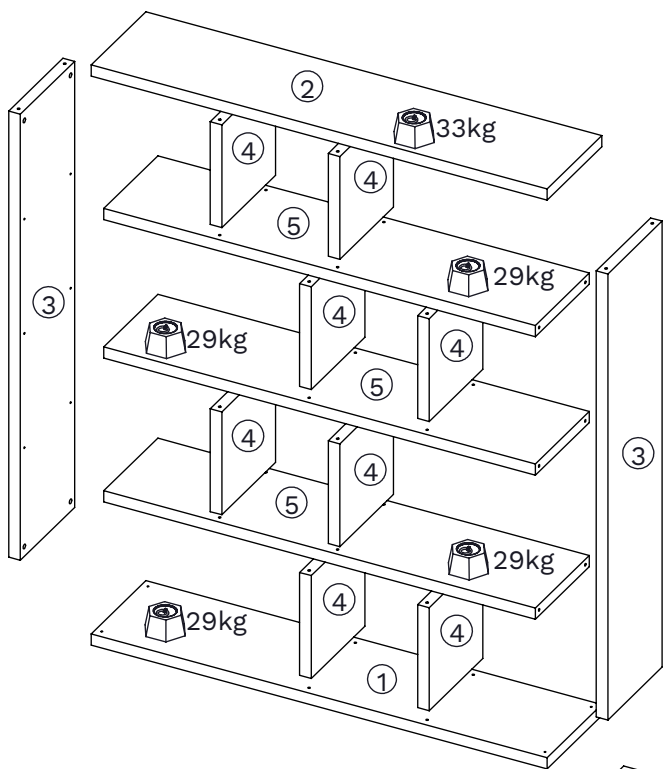

○	x	mm	
1	1	1500 x 340 x 38	1
2	1	1500 x 340 x 38	1
3	2	1514 x 338 x 38	1
4	8/10	349 x 334 x 38	1/2/3
5	3/4	1419 x 336 x 38	1/3
6	2	1902 x 338 x 38	2

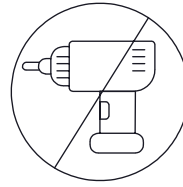
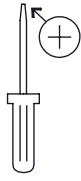

Ø7 x 41mm
BAA x 36/44



AAA x 36/44



Ø6 x 60mm
GGO x 16/20



Ø4 x 16mm
GGS x 1

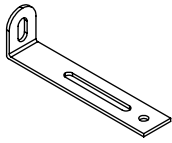

NET x 1



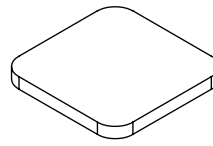

EDE x 52/64



EDX x 4

1

BAA x 12  Ø7 x 41mm	AAA x 28 	GGO x 12  Ø6 x 60mm
---	---	--

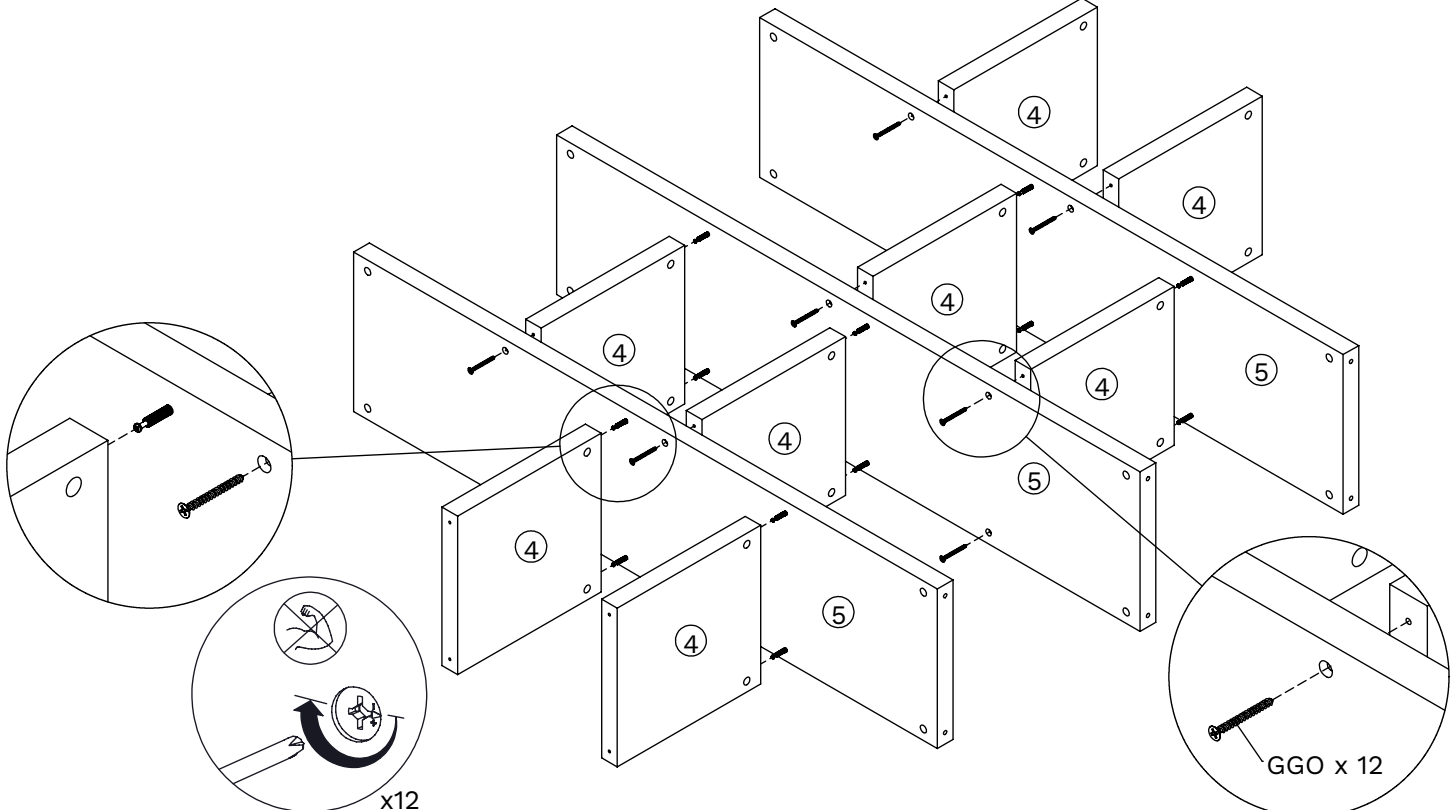
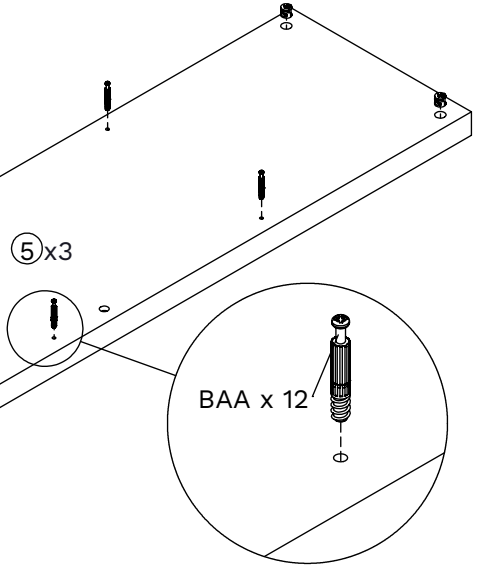
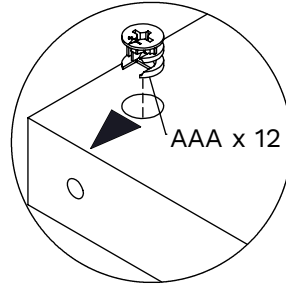
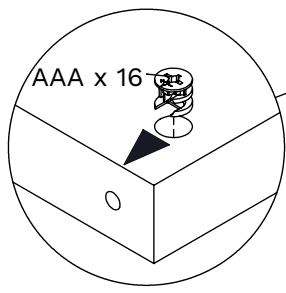
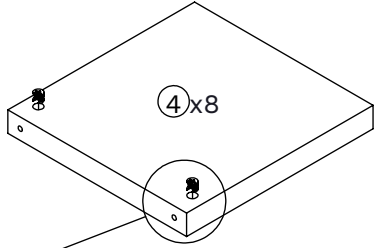
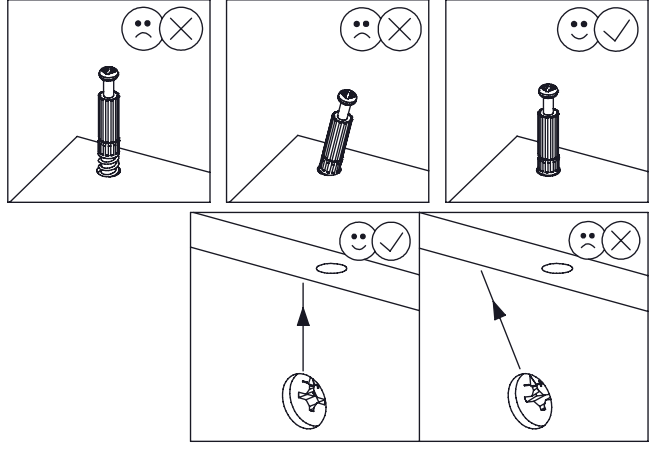
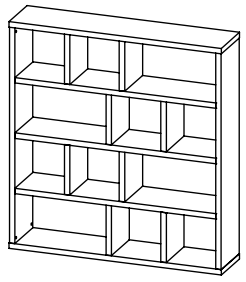
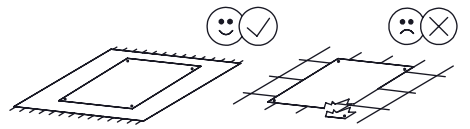
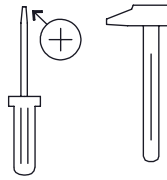



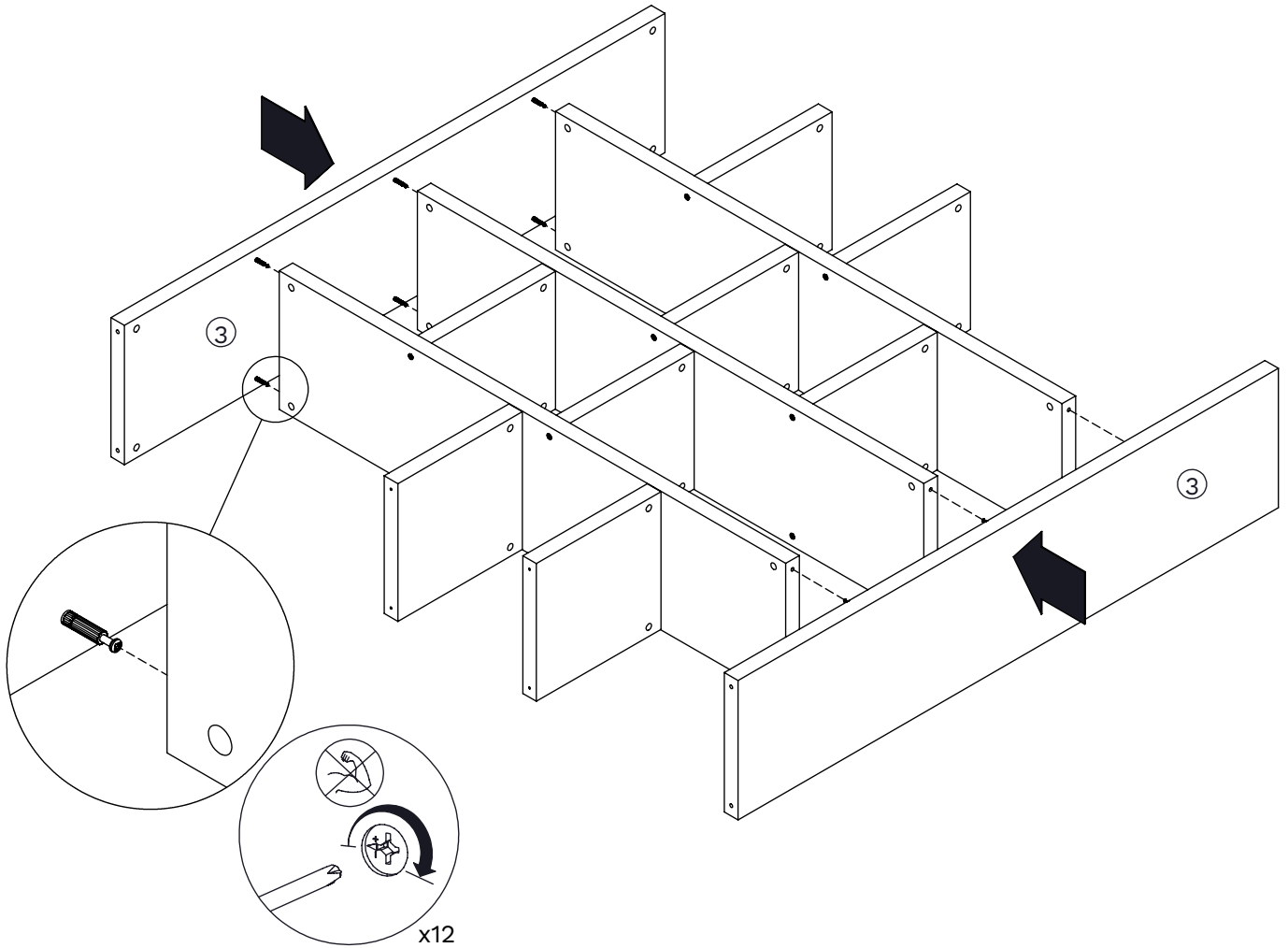
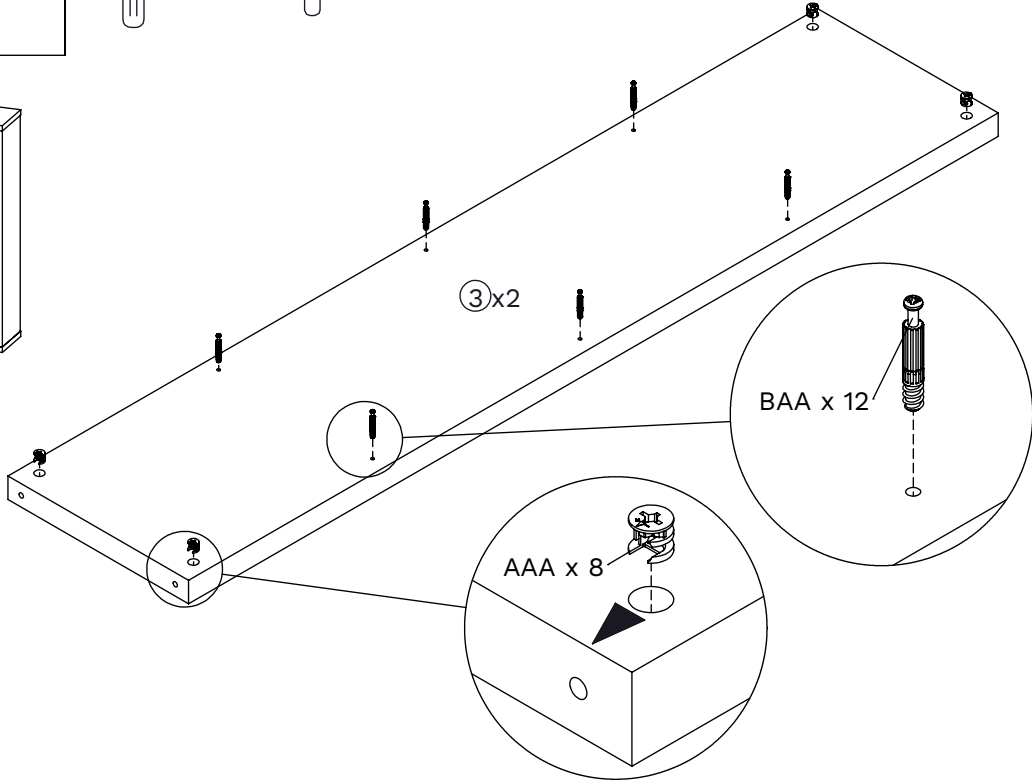
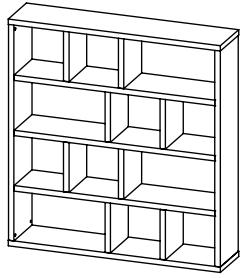
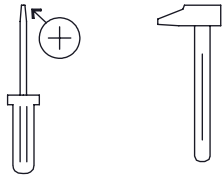
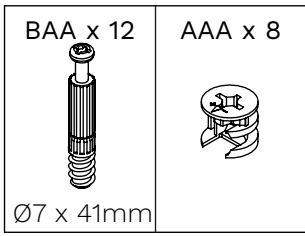

x12

GGO x 12

2

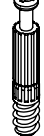

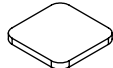

3

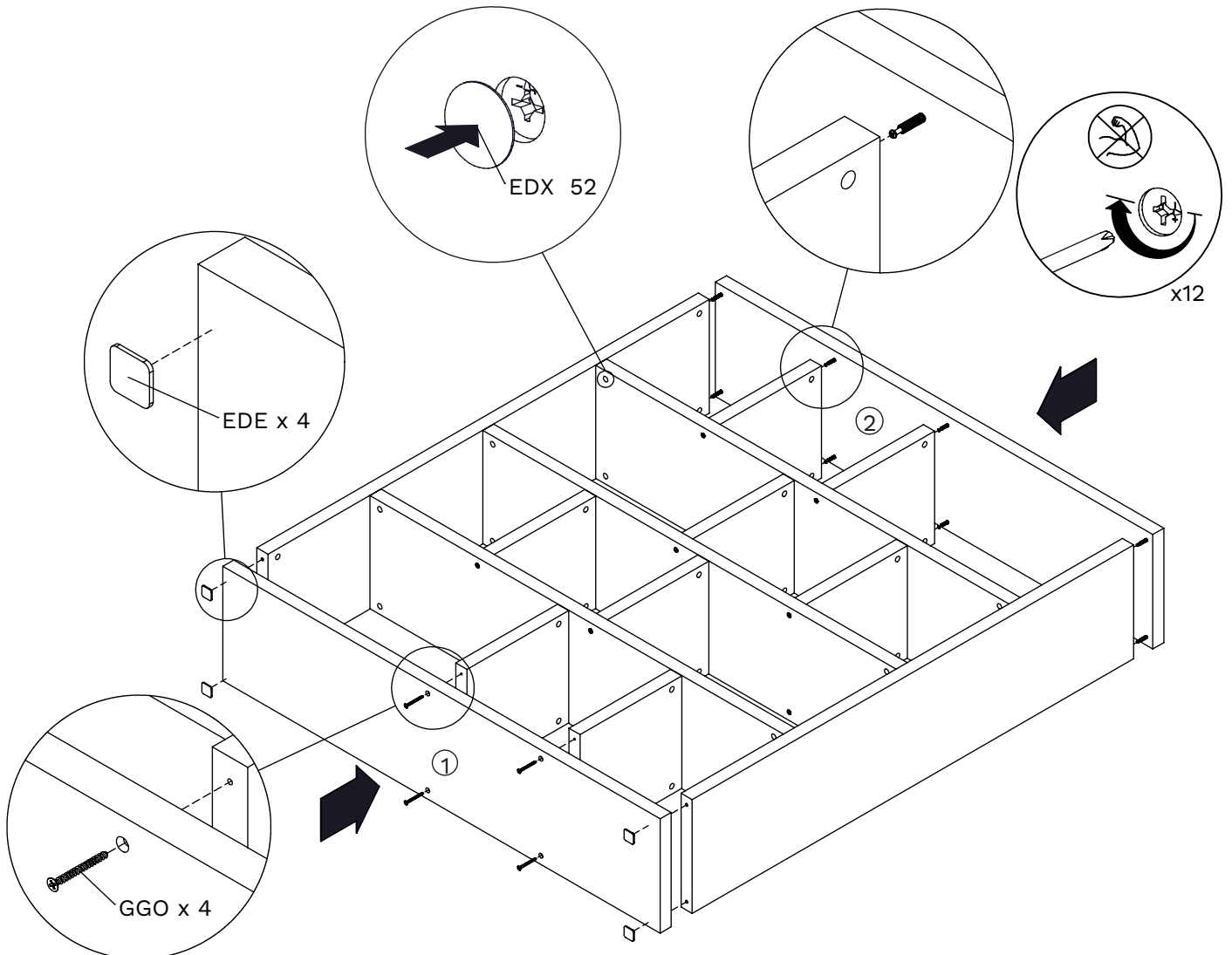
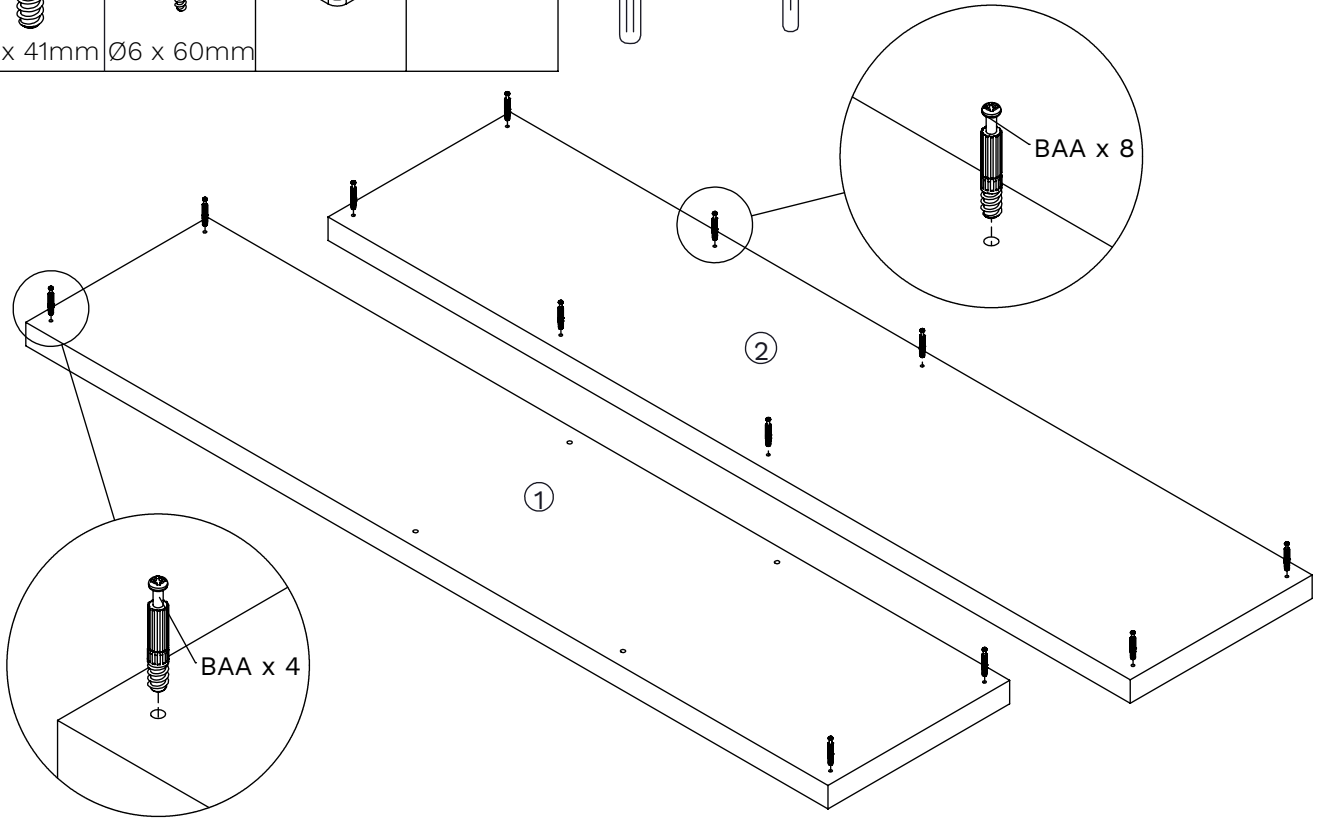
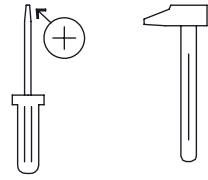
BAA x 12  Ø7 x 41mm	GGO x 4  Ø6 x 60mm	EDX x 52 	EDE x 4 
--	---	---	--



4



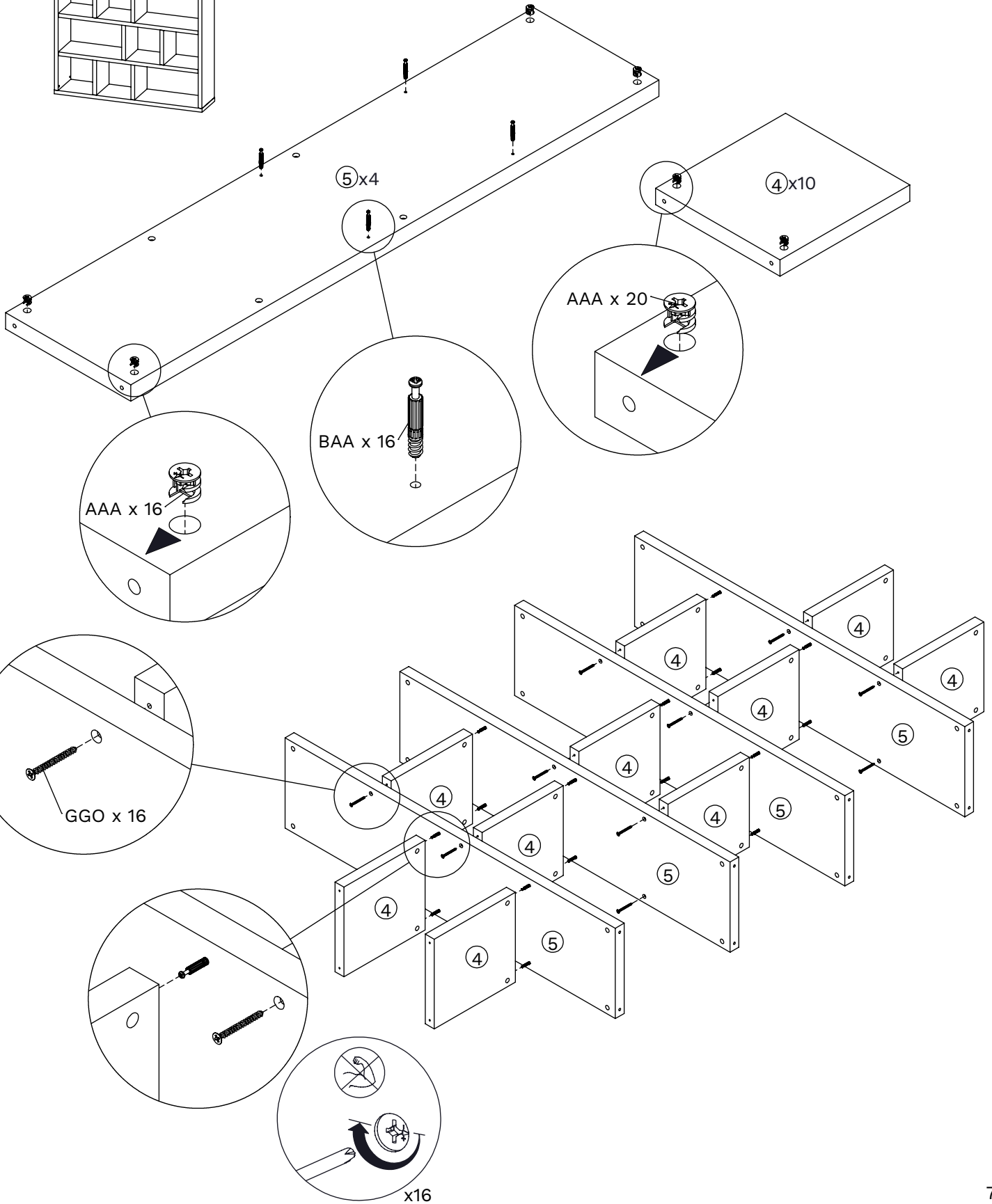
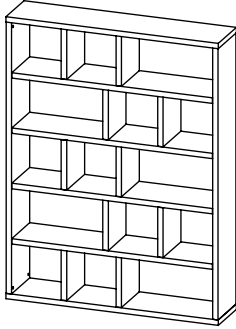
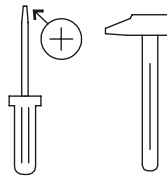

BAA x 16  Ø7 x 41mm	AAA x 36 	GGO x 16  Ø6 x 60mm
---	---	--

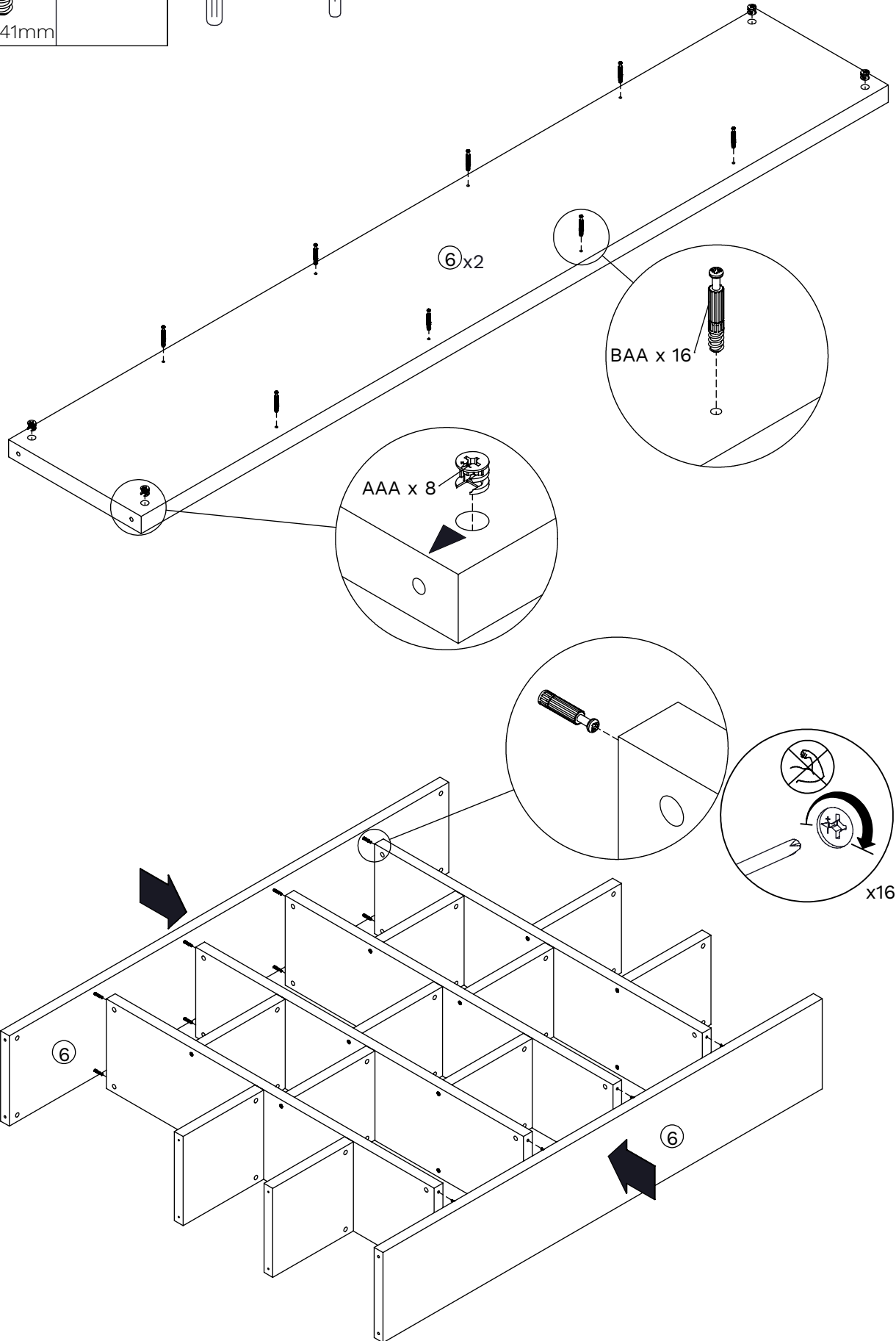
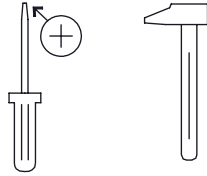
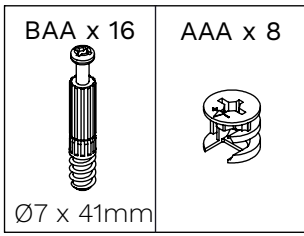

5

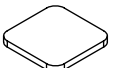

6

BAA x 12  Ø7 x 41mm	GGO x 4 	EDX x 4 	EDE x 64 
---	--	--	---

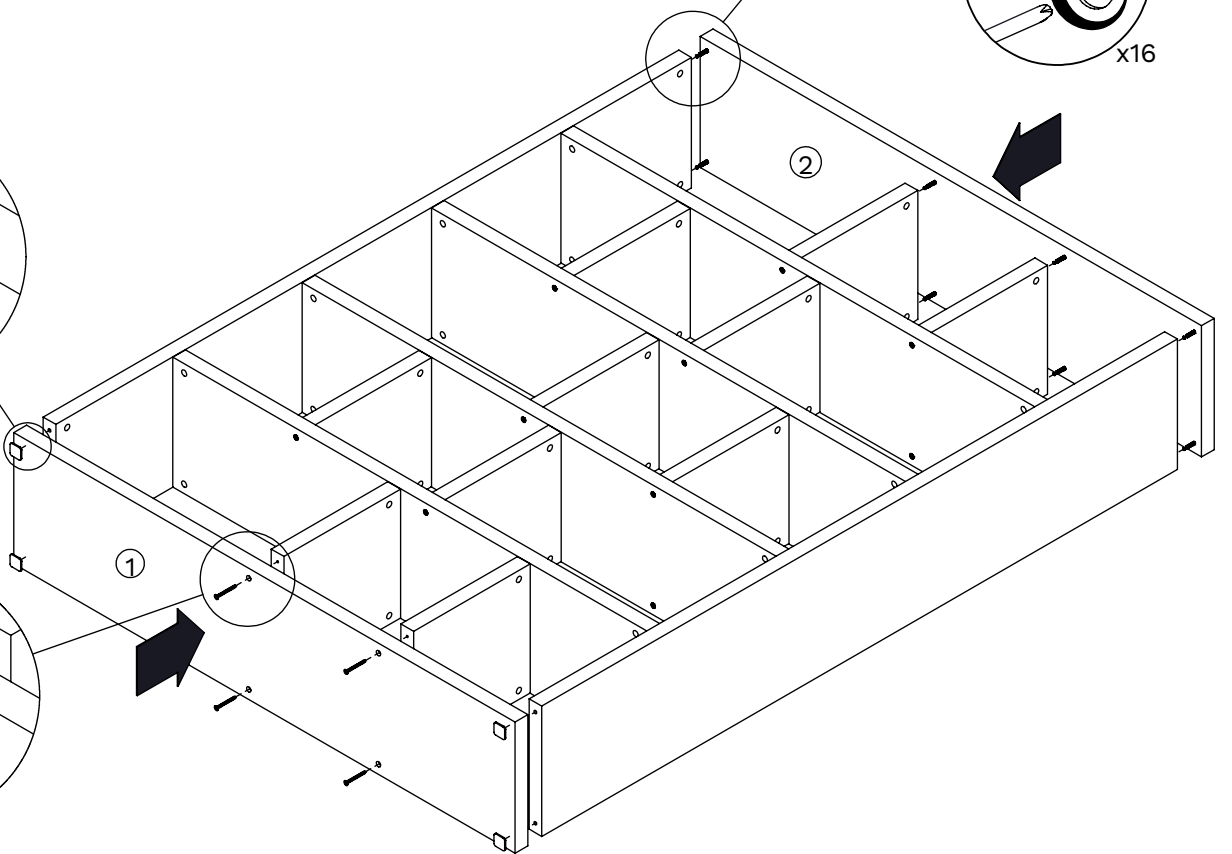
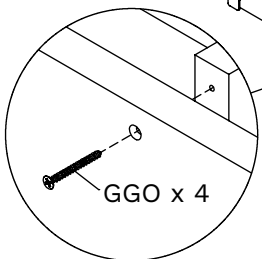
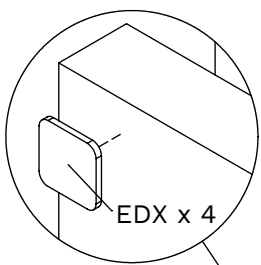
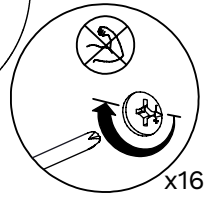
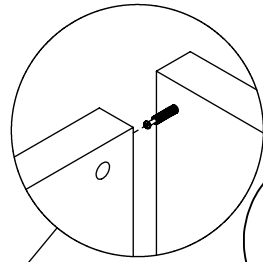
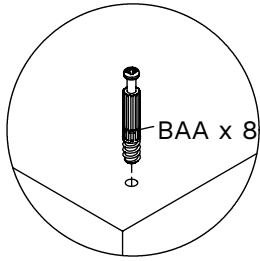
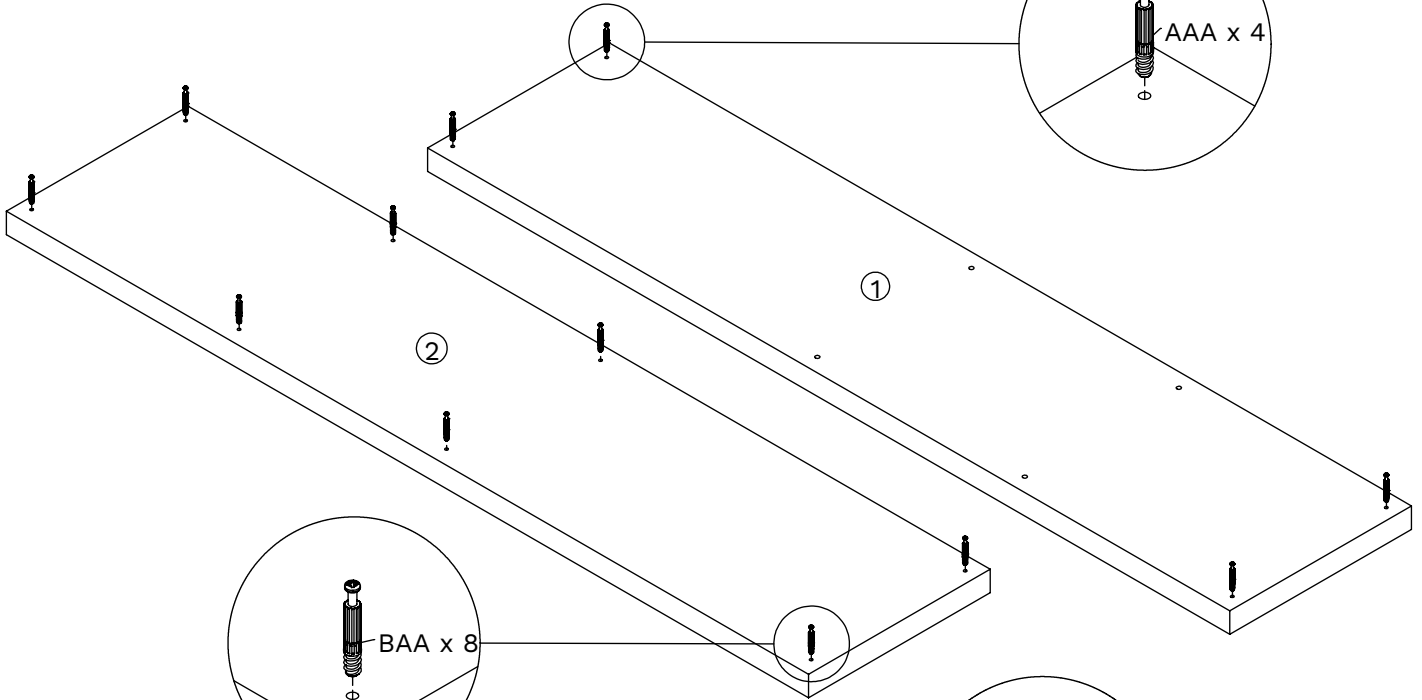
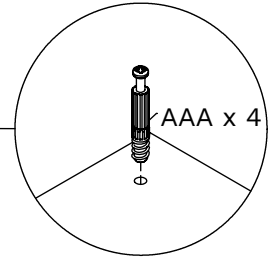
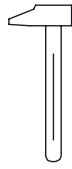
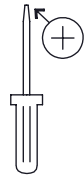

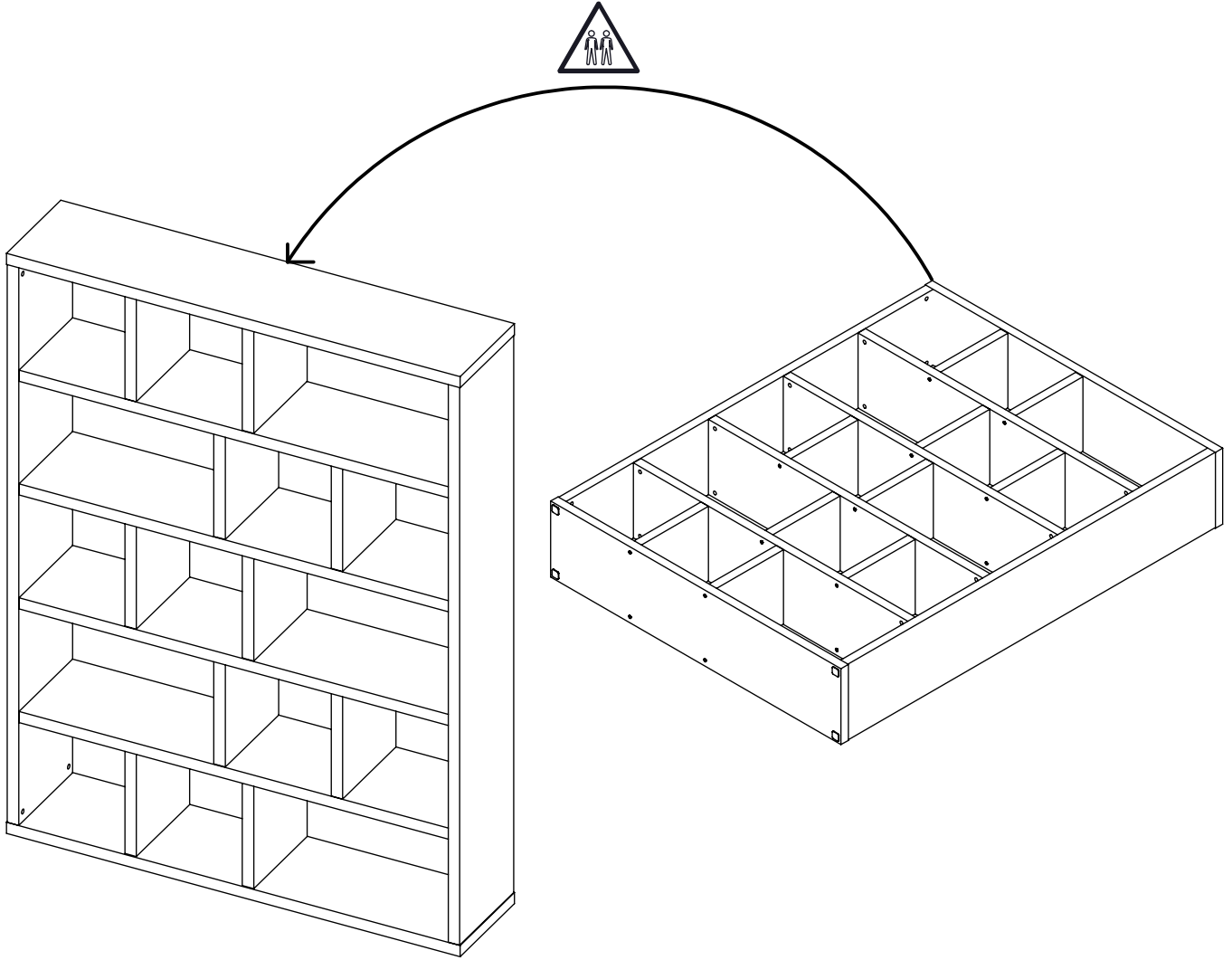
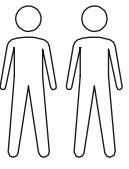

7

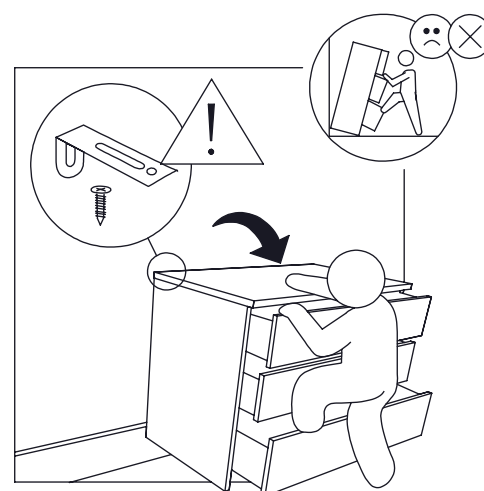
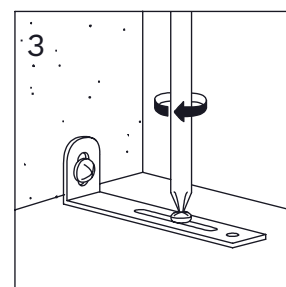
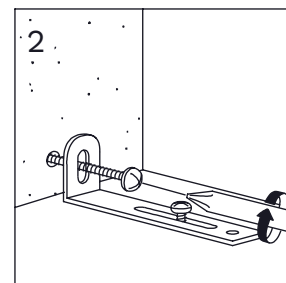
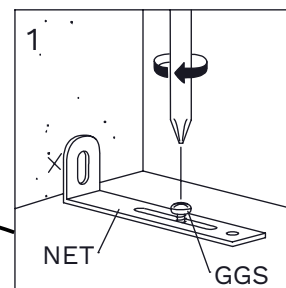
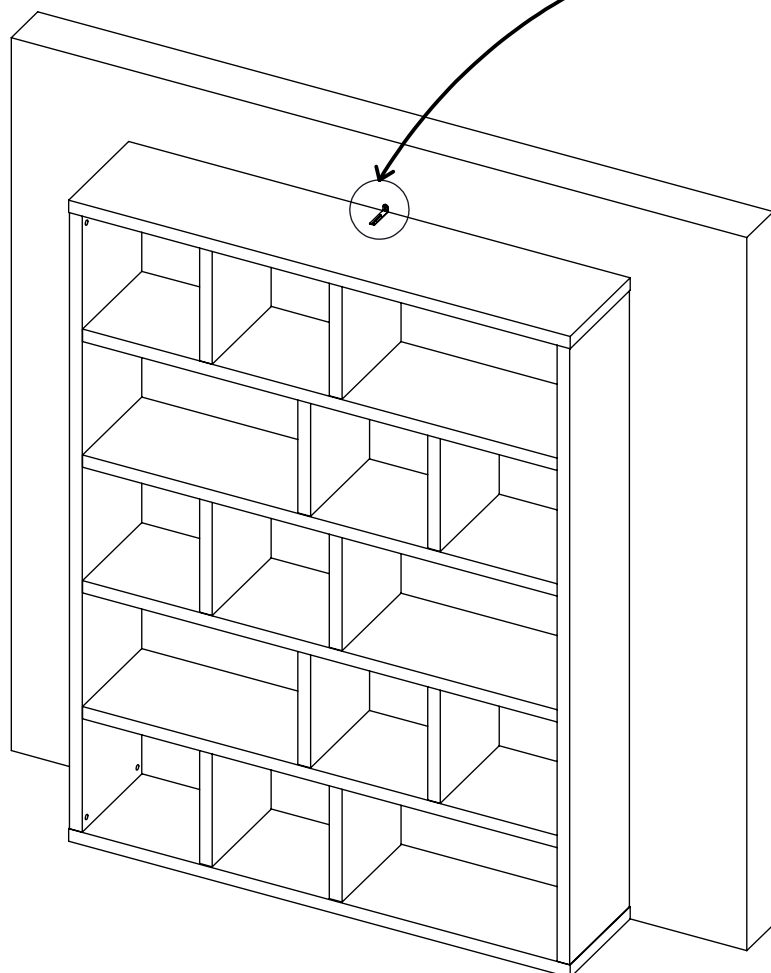
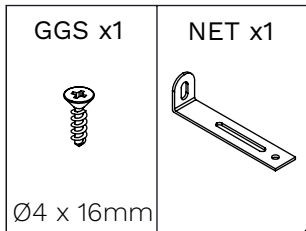

8



 Achtung • Attention • Attenzione • Opgelet • Uwaga • Pozor • Figyelem Atenție • Dikkat • Внимание • Atención • Atenção 			
D	Wandbefestigung dient als Kippschutz - unbedingt anbringen! Bei einigen Wandtypen kann ein Spezialdübel erforderlich sein!	CZ	Montáž na stěnu slouží jako ochrana proti převrnutí - bezpodmínečně umístěte! U některých typů stěn může být zapotřebí speciální hmoždinka!
GB	The wall fastening serves to prevent tipping - be absolutely sure to mount it! For certain wall types, a special wall plug may be necessary!	SK	Upevnenie na stenu slúži ako ochrana proti prevráteniu – bezpodmienečne použite! Pre niektoré druhy stien môže byť potrebná špeciálna hmoždinka!
FR	La fixation murale sert de protection contre le basculement - à installer impérativement ! Pour certains types de murs il faut des chevilles spéciales !	HU	A terméket a falhoz kel rögzíténi, különben az felborulhat! Egyes faltípusoknál speciális tiplit kell használni!
IT	Il fissaggio alla parete serve da protezione anti-ribaltamento - attaccarla assolutamente! Per alcune strutture di parete può essere necessario un tassello speciale!	RO	Sistemul de fixare la perete servește ca protecție la răsturnare - de montat obligatoriu! Pentru unele tipuri de pereți este posibil să fie necesar un diblu special!
NL	Bevestiging aan de muur dient als kantelbescherming - zeker en vast bevestigen! Bij enkele muurtypes is een speciale plugmisschien vereist!	TR	Duvardaki sabitleme, devrilmeye karşı bir emniyet tedbiridir ve mutlaka monte edilmelidir! Bazı duvar tiplerinde bunun için özel bir dübel gerekli olabilir!
PL	Mocowanie do ściany jest jednocześnie zabezpieczeniem przed przewróceniem - koniecznie zamontować! Do niektórych rodzajów ścian konieczne zastosować specjalne kołki mocujące.	PT	A fixação do produto à parede serve para prevenir que este tombe! Certifique-se que executa este passo correctamente. Para determinados tipos de parede pode ser necessário utilizar uma bucha especial!
ES	La fijación a la pared sirve para evitar vuelcos. ¡Asegúrate de montarlo! ¡Para ciertos tipos de pared, se necesitan tacos especiales!	RU	Обязательно установите крепление на стене во избежание опрокидывания! Для некоторых типов стен может потребо- ваться специальный дюбель!

