



Paulmann

### Safety Instructions

1, 2, 3, 4, 5, 6, 7, 8, 16, 19,  
22, 23, 24, 29, 32, 33, 34



Info

[www.paulmann.com](http://www.paulmann.com)

Paulmann Licht GmbH  
Quezinger Feld 2  
31832 Springe  
Germany

[www.paulmann.com](http://www.paulmann.com)

Art.-Nr.: 977.65  
977.66  
969.21  
(+MA326) PH 07/22



1x

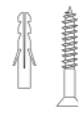

incl.

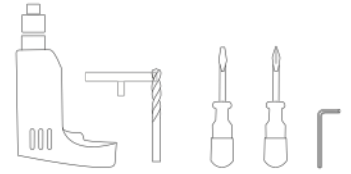

A

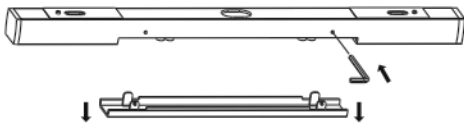

B

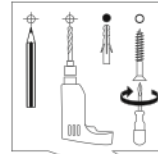

Safety  
Instructions  
Nr. 1-8,19

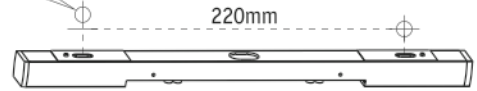

C1 C2

Cable NYM-J  
3x max. 1,5 mm<sup>2</sup>

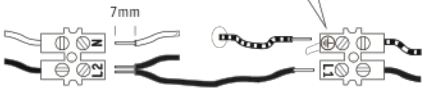

C1 C2

Cable NYM-J  
5x max. 1,5 mm<sup>2</sup>

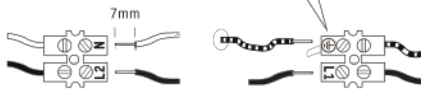

L2 L1



D

1.

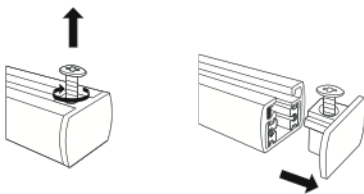

3.

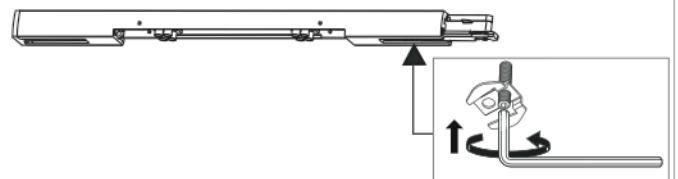

2.



4.

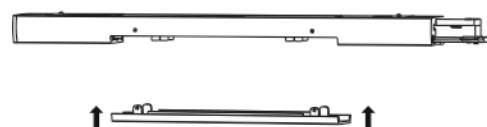

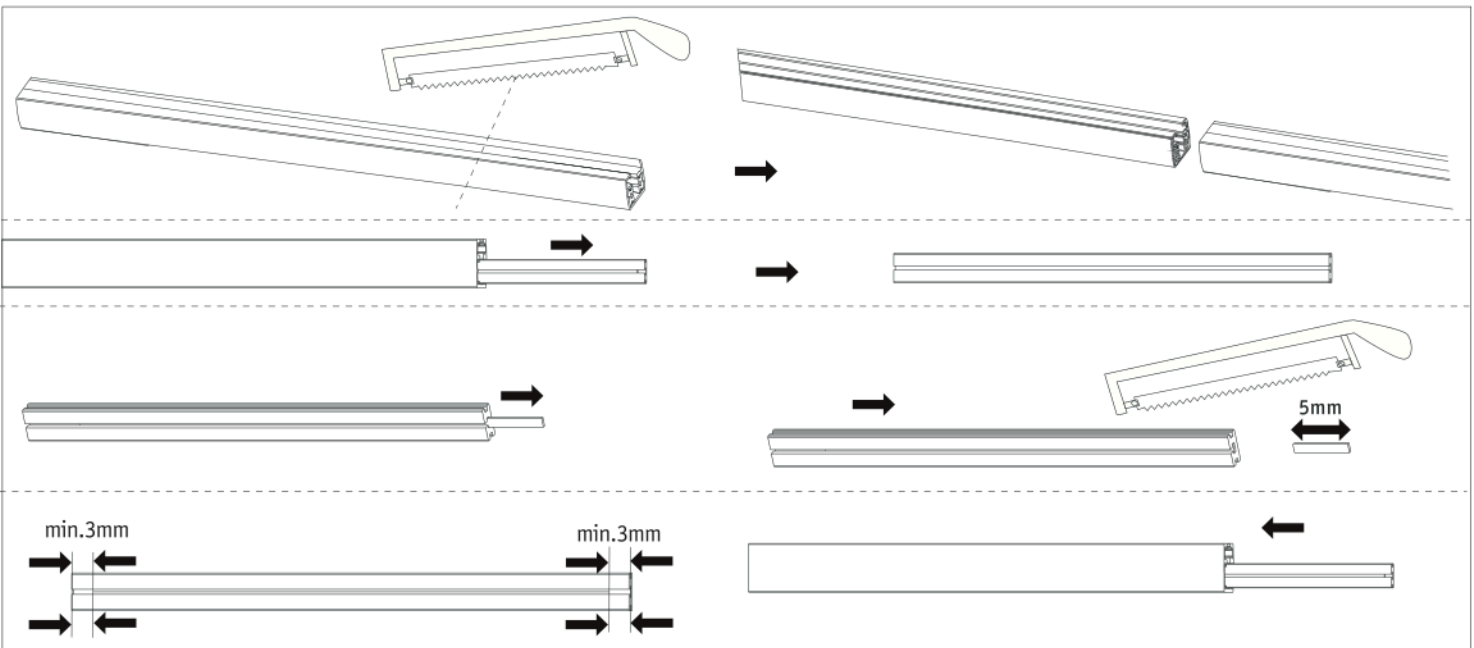
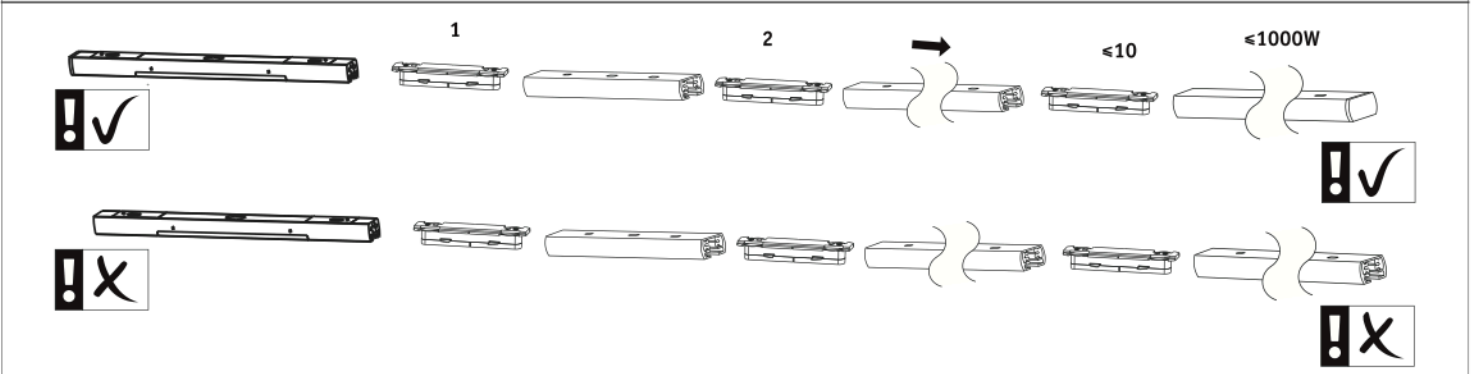
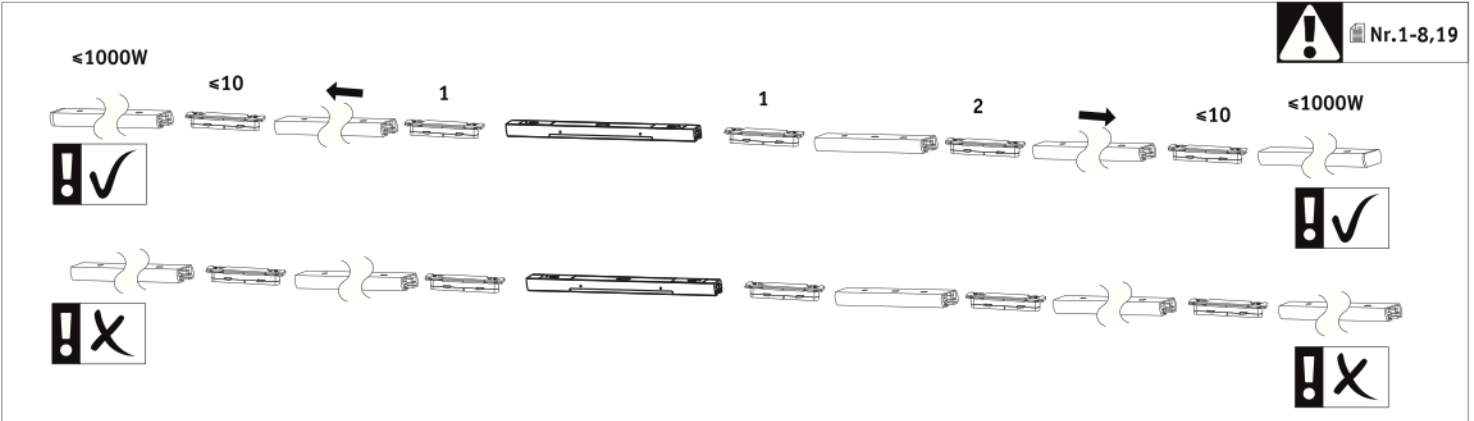
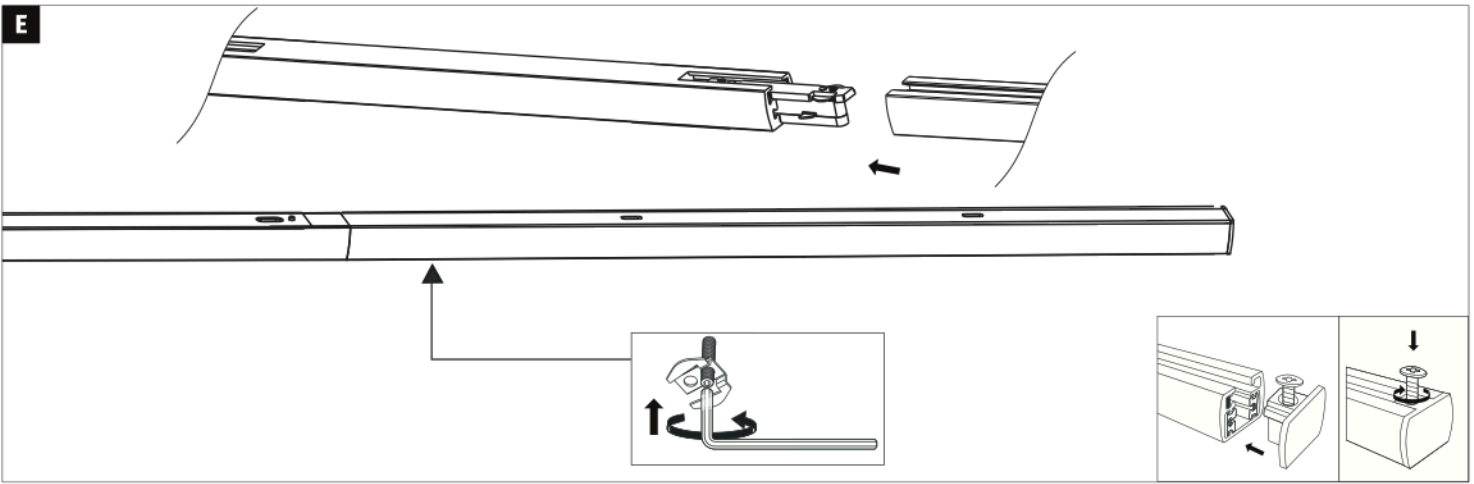

**!** Altgeräte dürfen nicht in den Restmüll. Sie können bei öffentlichen Sammelstellen von Entsorgungsträgern abgegeben werden. Altbatterien und Altakkumulatoren, sowie Lampen, die zerstörungsfrei aus dem Altgerät entnommen werden können, sind vor der Abgabe an eine Erfassungsstelle von dem Altgerät zu trennen. Vertreiber sind im Rahmen von § 17 Absatz 1 und 2 ElektroG zur unentgeltlichen Rücknahme dieses Produktes verpflichtet. Endnutzer von Altgeräten müssen eigenverantwortlich für die Löschung personenbezogener Daten auf den zu entsorgenden Altgeräten sorgen.

www.paulmann.com