

REPC-Nr.:

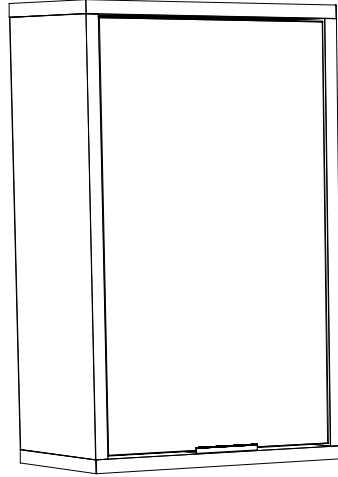

Artikel.-Nr.:

1000-HS-1-41

Montageanleitung.-Nr.:



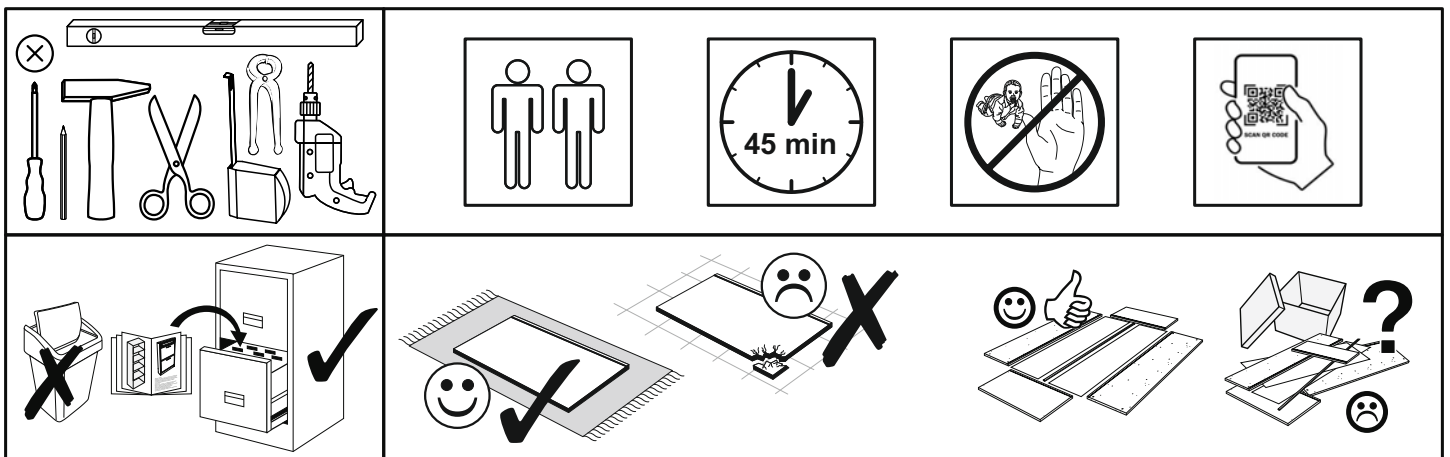







MA1-00533



SCAN ME

Das Ersatzteil-Anforderungsformular finden Sie auf
The replacement parts requisition form you find on
<https://www.mausbacher.de/ersatzteile/>

BT1-00633 Colli 1/1

B01-200 2x  6,3x13	B01-244 1x 	B01-80 4x  3,5x13	B02-103 4x  8x30	B02-160 4x 
B02-10 8x  ø15x12mm	B02-20 8x 	B08-40 2x  5,8x65	B08-70 2x  ø8mm	B08-80 1x 



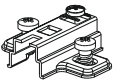
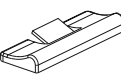

▶ SCAN ME

BT1-00228 Colli 1/1

B03-43 2x 	B03-11 2x 	B03-07 1x 
---	---	---

BT1-00634 Colli 1/1

B06-425 1x 	B05-02 8x  ø20mm
--	--

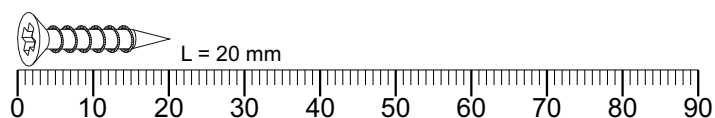

Colli 1/1

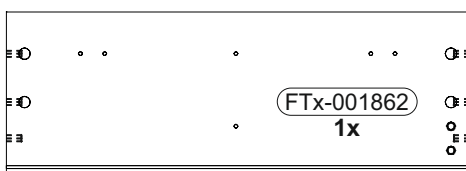

612 x 220

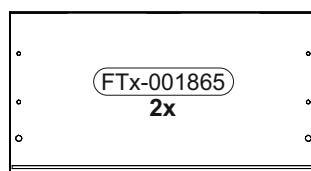

407 x 220

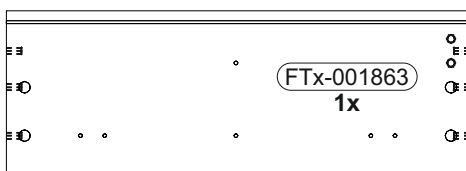

612 x 220

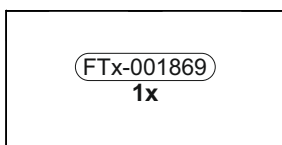

368 x 185

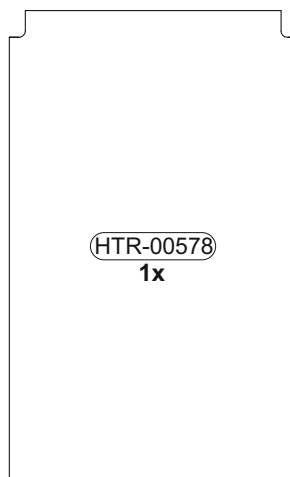

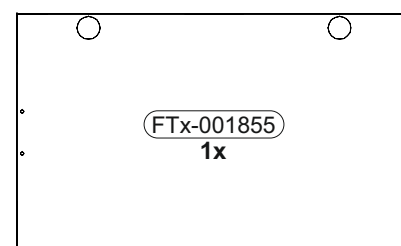
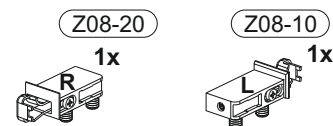

624 x 380



604 x 364

1

B02-10		B02-160		B02-103	
8x	ø15x12mm	4x		4x	8x30

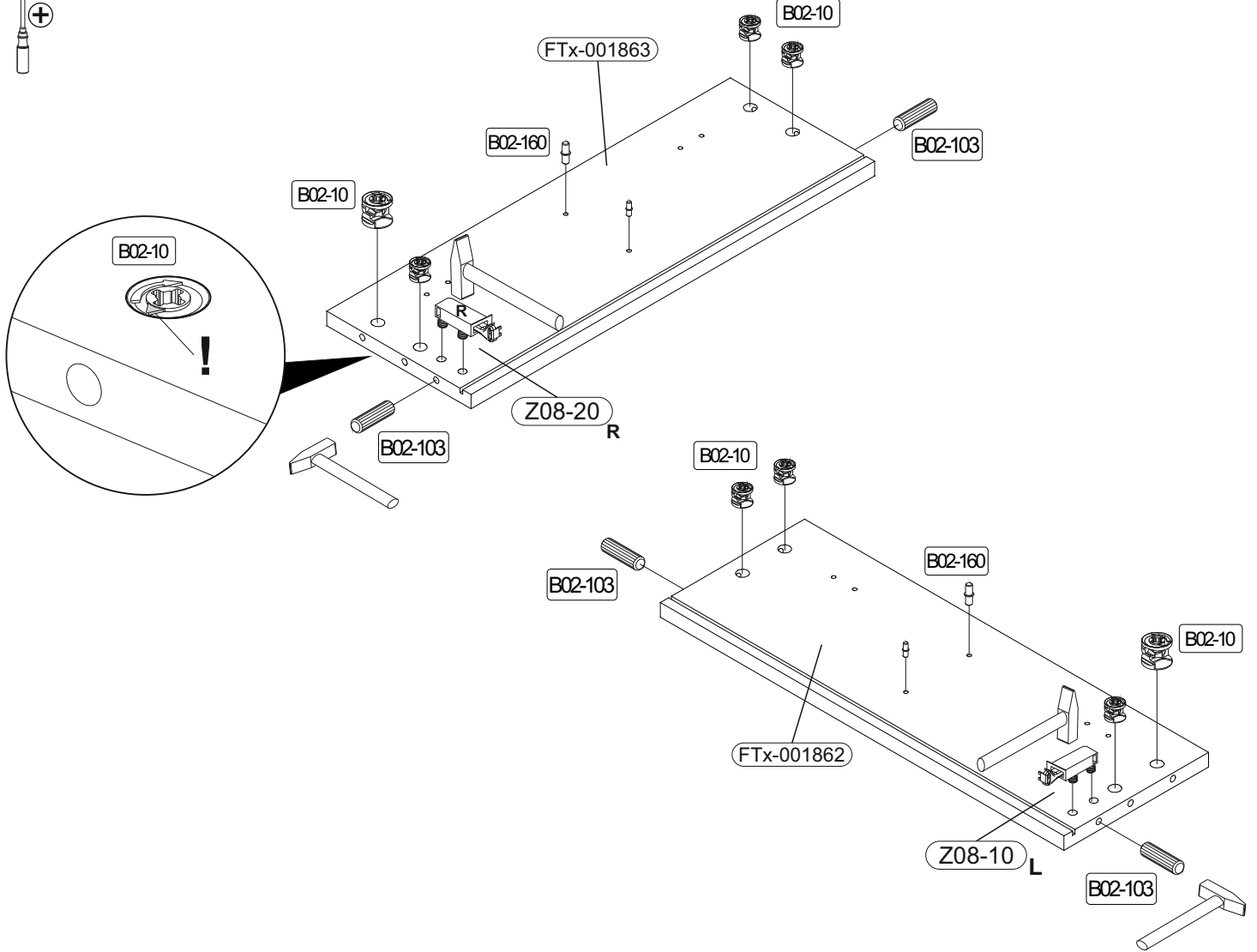

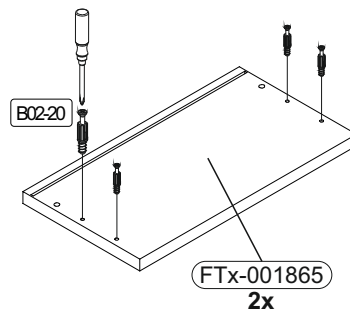
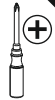

2

B02-20	
8x	



3

B01-80		B03-43	
4x	3,5x13	2x	

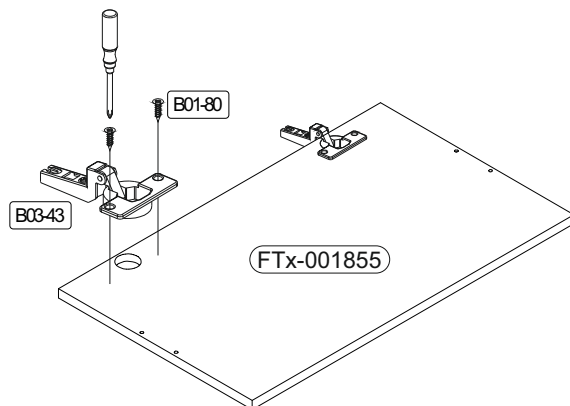

4

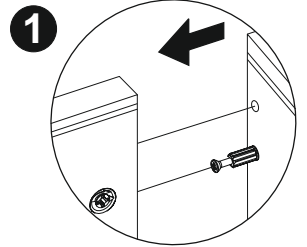
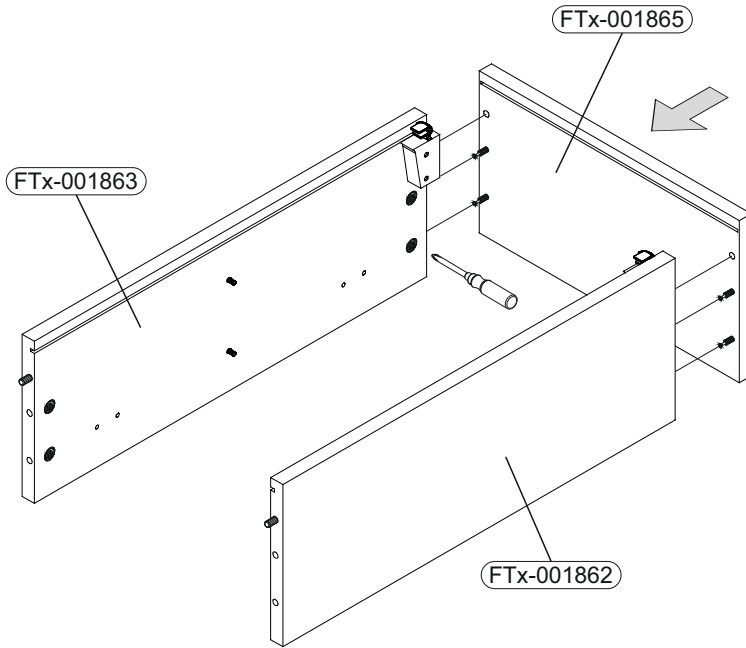

5

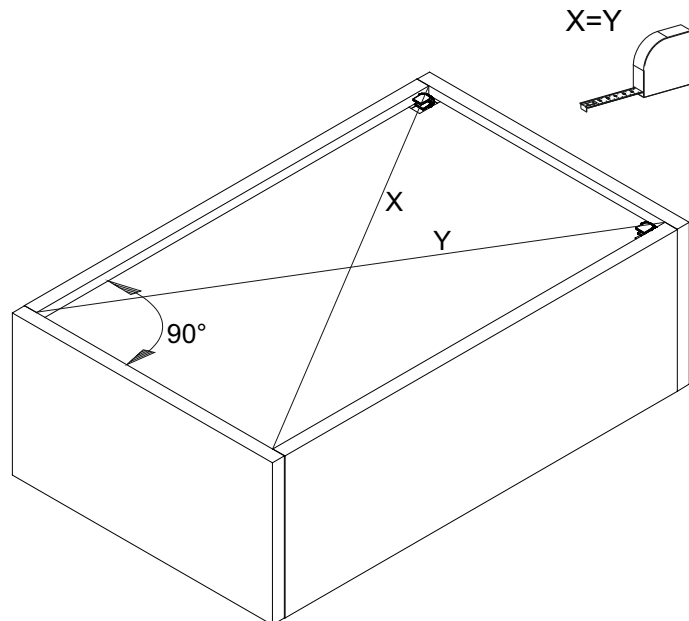
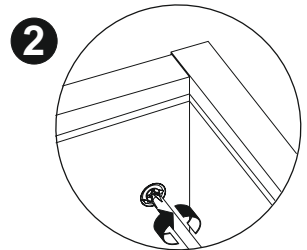
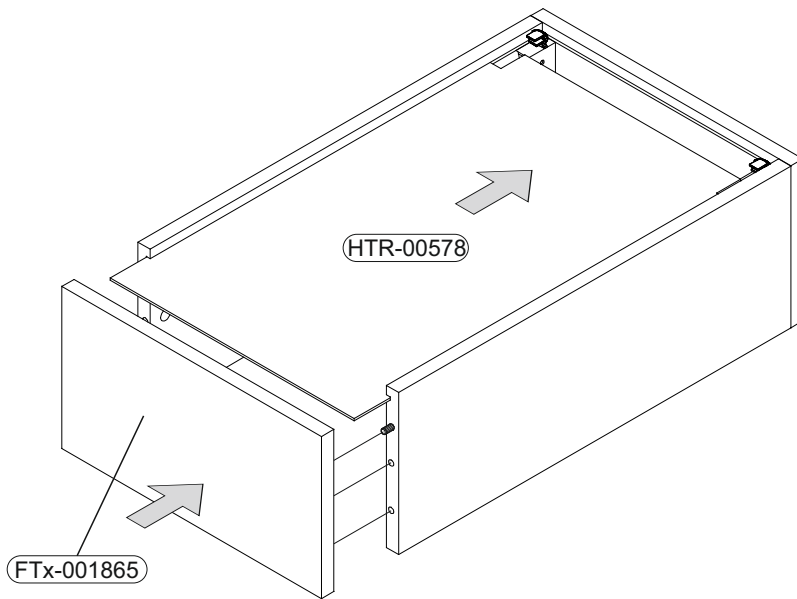



B08-40		B08-70		B01-244		B05-02		B08-80	
2x	5,8x65	2x	ø8mm	1x		8x	ø20mm	1x	



SCAN ME

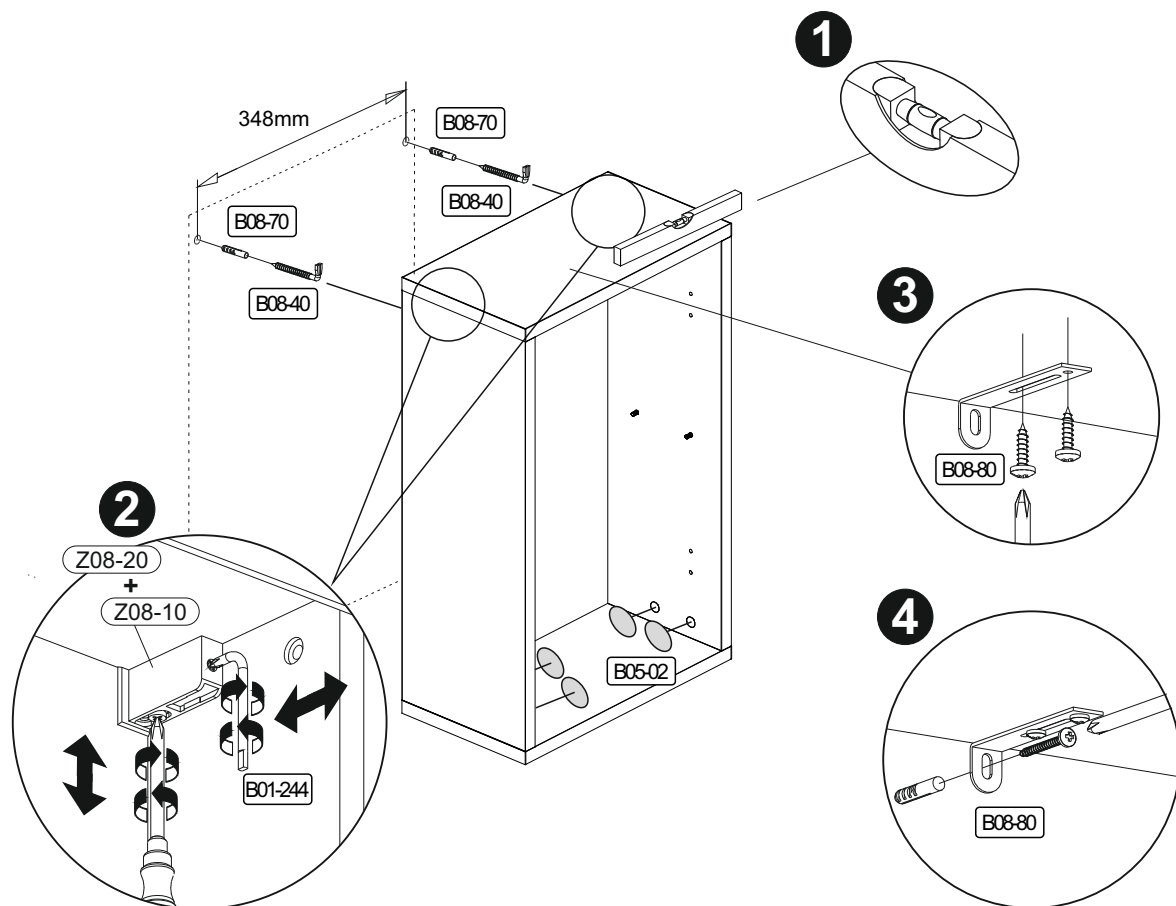
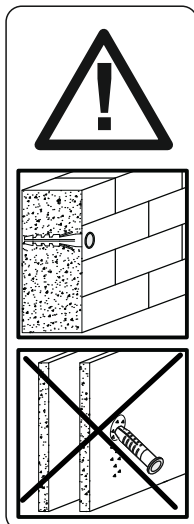

Achtung • Attention • Attenzione • Opgelet • Uwaga • Pozor • Figyelem • Atenție • Dikkat • Внимание • Fara • Vaara • Fare • Peligro	
(D)	Wandbefestigung dient als Kippschutz - unbedingt anbringen! Bei einigen Wandtypen kann ein Spezialdübel erforderlich sein!
(GB)	The wall fastening serves to prevent tipping - be absolutely sure to mount it! For certain wall types, a special wall plug may be necessary!
(FR)	La fixation murale sert de protection contre le basculement – à installer impérativement ! Pour certains types de murs il faut des chevilles spéciales !
(TR)	Duvardaki sabitleme, devrilmeye karşı bir emniyet tedbiridir ve mutlaka monte edilmelidir! Bazı duvar tiplerinde bunun için özel bir dübel gerekli olabilir!
(IT)	Il fissaggio alla parete serve da protezione anti-ribaltamento – attaccarla assolutamente! Per alcune strutture di parete può essere necessario un tassello speciale!
(NL)	Bevestiging aan de muur dient als kantelbescherming – zeker en vast bevestigen! Bij enkele muurtypes is een speciale plug misschien vereist!
(RU)	Обязательно установите крепление на стене во избежание опрокидывания! Для некоторых типов стен может потребоваться специальный дюбель!
(CZ)	Montáž na stěnu slouží jako ochrana proti převrnutí – bezpodmínečně umístěte! U některých typů stěn může být zapotřebí speciální hmoždinka!
(HU)	A termék a falhoz kel rögzíténi, különben az felborulhat! Egyes faltípusoknál speciális tiplit kell használni!
(RO)	Sistemul de fixare la perete servește ca protecție la răsturnare - de montat obligatoriu! Pentru unele tipuri de pereți este posibil să fie necesar un diblu special!
(PL)	Mocowanie do ściany jest jednocześnie zabezpieczeniem przed przewróceniem – koniecznie zamontować! Do niektórych rodzajów ścian koniecznie zastosować specjalne kołki mocujące.
(SWE)	Väggmontering fungerar som anti-lutnings skydd - det är viktigt att fästa det! En speciell plugg kan behövas för vissa väggtyper!
(FIN)	Seinäkiinnitys toimii kaatumista estävänä suojana - se on ehdottomasti kiinnitettävä! Joihinkin seinätyypeihin voidaan tarvita erityistappi!
(NOR)	Veggmontering fungerer som anti-vippebeskyttelse - det er viktig å feste det! En spesiell dyvel kan være nødvendig for noen veggtyper!
(DAN)	Vægmontering fungerer som anti-vip beskyttelse - det er vigtigt at fastgøre det! En speciel dyvel kan være påkrævet til nogle vægtyper!
(SK)	Upevnenie na stenu slúži ako ochrana proti prevráteniu – bezpodmienečne použite! Pre niektoré druhy stien môže byť potrebná špeciálna hmoždinka!
(ES)	El montaje en la pared sirve como protección antivuelco: ¡es imprescindible fijarlo! ¡Es posible que se requiera una espiga especial para algunos tipos de paredes!

10

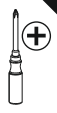

B03-11		B03-07		B01-200		B06-425	
2x		1x		2x	6,3x13	1x	

