

**VITO TICONA  
PAYTON**

**D** MONTAGEANLEITUNG  
BEDIENUNGSANLEITUNG

**NL** HANDLEIDING VOOR DE MONTAGE  
GEBRUIKSAANWIJZING

**TR** MONTAJ TALIMATI  
KULLANIM KLAVUZU

**RO** INSTRUCȚIUNI DE INSTALARE  
INSTRUCȚIUNI DE UTILIZARE

**FR** NOTICE DE MONTAGE  
MANUEL INSTRUCTIONS

**HU** KÖZGYŰLÉS UTASÍTÁSOK  
KEZELÉSI UTASÍTÁS

**SI** NAVODILA ZA MONTAŽO  
NAVODILA ZA UPORABO

**ES** INSTRUCCIONES DE MONTAJE  
MANUAL DEL USUARIO

**GB** ASSEMBLY INSTRUCTIONS  
INSTRUCTION MANUAL

**PL** INSTRUKCJA MONTAŻU  
INSTRUKCJA OBSŁUGI

**RU** ИНСТРУКЦИЯ ПО МОНТАЖУ  
ИНСТРУКЦИЯ ПО ЭКСПЛУАТАЦИИ

**IT** ISTRUZIONI DI MONTAGGIO  
MANUALE DI ISTRUZIONI

**SK** MONTÁŽNY NÁVOD  
NÁVOD NA POUŽITIE

**CZ** MONTÁŽNÍ NÁVOD  
NÁVOD K POUŽITÍ

**PT** INSTRUÇÕES DE MONTAGEM  
MANUAL DO USUÁRIO

**HR** UPUTE ZA MONTAŽU  
UPUTE ZA UPOTREBU

Service · Dienstverlening · Serwis · Servis · Сервисная служба · Serviciu · Services · Servizio · Servisný list · Szolgáltatás · Servisní list

Name · Naam · Nazwa · İsim · Название · Nume · Nome ·  
Názov · Názov · Název · Neve

Тур · Туре · Тір · Тип · Тіро · Típus

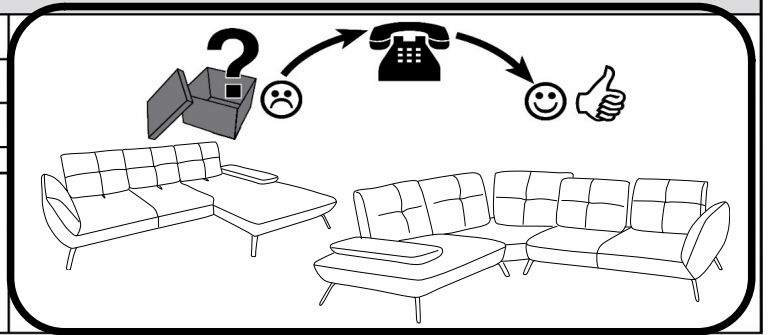
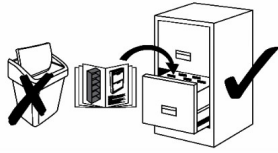

✓	Var. B		 A a1	 B M6x25	 C	 D 4L
 2er			4 x A 4 x a1	4x <b>3B</b>	1C	
 2er			2 x A 2 x a1	2x <b>3B</b>	1C	
 2er			4 x A 4 x a1	2x <b>3B</b> + 2x <b>4B</b>	1C	1D
 3er			4 x A 4 x a1	4x <b>3B</b>	2C	
 3er			2 x A 2 x a1	2x <b>3B</b>	2C	
 3er			4 x A 4 x a1	2x <b>3B</b> + 2x <b>4B</b>	2C	

✓

**Var. B**

**A**

**B**  
M6x25

**C**

**D**  
4L

**E**  
5L  
M8x30  
e1

a1

**A** **A** (x3B) (x4B)

**A** **A** (x3B) (x4B)

4xA  
4xa1

2x**3B**  
+  
2x**4B**

/

/

**A** **A** (x3B) (x3B)

**A** **A** (x3B) (x3B)

2xA  
2xa1

2x**3B**

/

/

**A** **A** (x3B) (x4B)

**A** **A** (x3B) (x4B)

**C C** **C C** (x4B)

**A** **A** (x3B) (x4B)

4xA  
4xa1

2x**3B**  
+  
2x**4B**

2C

/

**A** **A** (x3B) (x3B)

**A** **A** (x3B) (x3B)

**C C** **C C** (x3B)

**A** **A** (x3B) (x3B)

4xA  
4xa1

4x**3B**

2C

1D

/

**A** **A** **C** **A**

**A** **A** **E** **A**

4xA  
4xa1

4x**3B**

1C

1xE  
1xe1

**A** **A** x3B x3B

**A** **A** x4B x4B

**C** **C** **C** **C**

**A** **A** **C** **C** **C** **C**

4xA  
4xa1

2x**3B**  
+  
2x**4B**

2C

/

Service · Dienstverlening · Serwis · Servis · Сервисная служба · Serviciu ·  
Services · Servizio · Servisný list · Szolgáltatás · Servisní list

Name · Naam · Nazwa · İsim · Название · Nume · Nome ·  
Názov · Názov · Název · Neve

Тур · Туре · Tip · Тип · Tiro · Típus

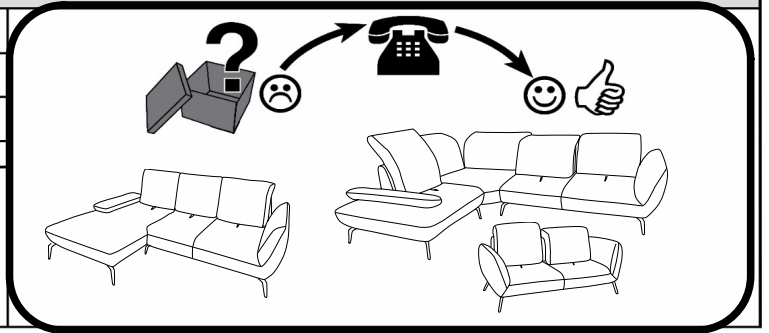
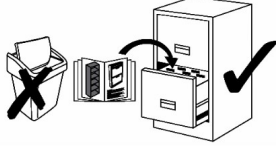









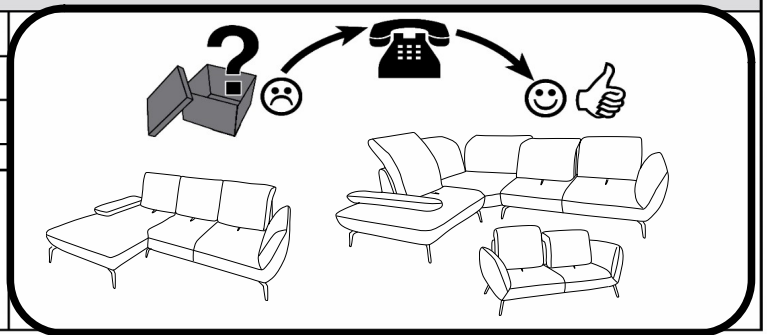
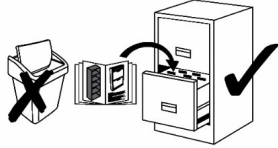

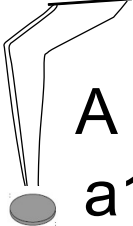
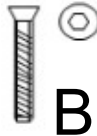
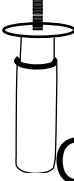







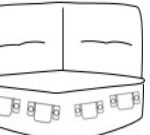

✓	Var. A		A a1	B M6x25	C	D 4L
			4 x A 4 x a1	4x4B	1C	1D
			2 x A 2 x a1	2x4B	1C	
			4 x A 4 x a1	4x4B	1C	
			4 x A 4 x a1	4x4B	2C	
			2 x A 2 x a1	2x4B	2C	
			4 x A 4 x a1	4x4B	2C	
			4 x A 4 x a1	4x4B	/	
			2 x A 2 x a1	2x4B	/	
			4 x A 4 x a1	4x4B	2C	

Service · Dienstverlening · Serwis · Servis · Сервисная служба · Serviciu · Services · Servizio · Servisný list · Szolgáltatás · Servisní list

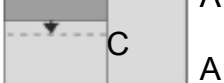
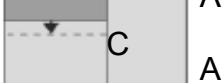
Name · Naam · Nazwa · İsim · Название · Nume · Nome ·  
Názov · Názov · Název · Neve

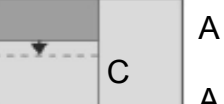
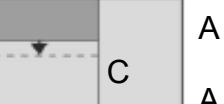
Тур · Туре · Tip · Тип · Típo · Típus

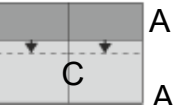
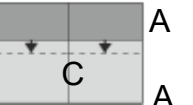

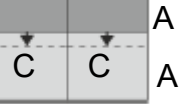
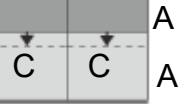
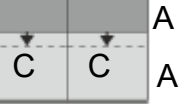
✓			 A a1	 B M6x25	 C	 D 4L	 E 5L	 F M8	 G M8x30
		A  A A  A	4 x A 4 x a1	4x4B	/	1D			
		C  A	1 x A 1 x a1	1x4B	1C	1D	1E	4xF	4xG
		A  A A  A	3 x A 3 x a1	3x4B	1C	1D	1E	8xF	8xG
		A  A A  A	4 x A 4 x a1	4x4B	1C	1D			
		 A A  A	2 x A 2 x a1	2x4B	1C	1D			
	 2er	 A C  A	2 x A 2 x a1	2x4B	1C	1D			
	 3er	 A C  C  A	2 x A 2 x a1	2x4B	2C	1D			

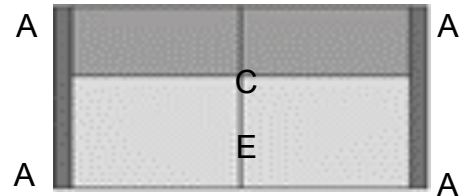
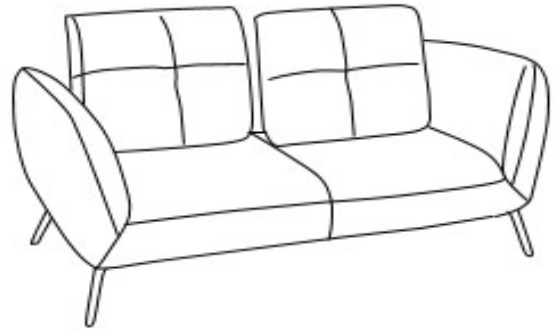
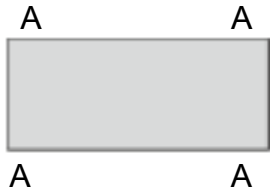
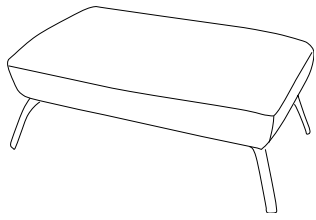

Megasofa

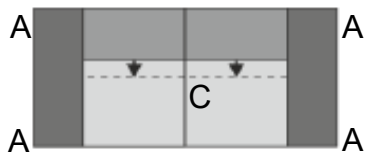
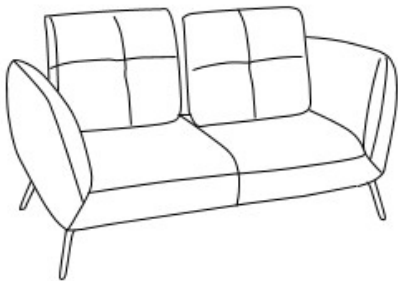

2er

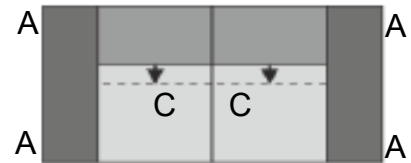
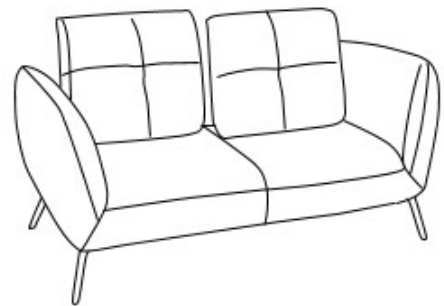

3er

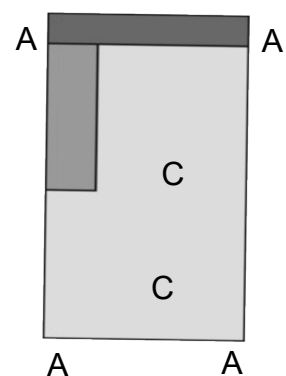
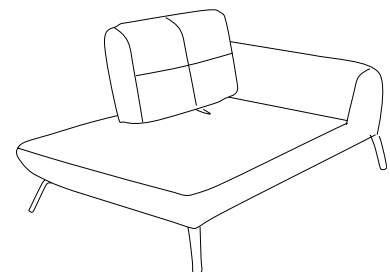
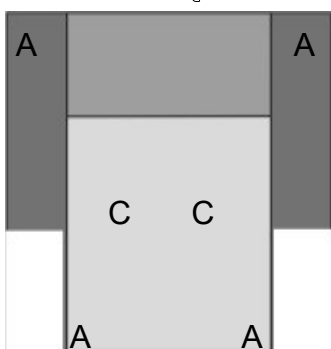
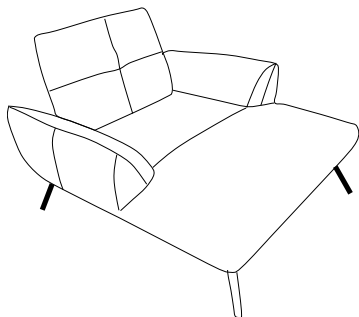

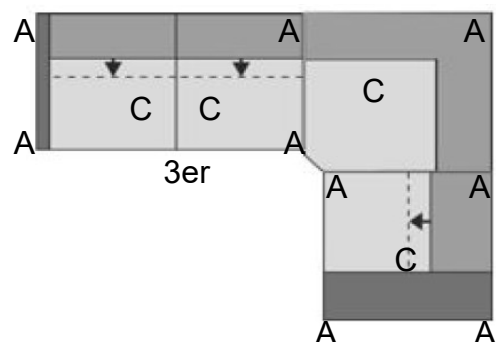
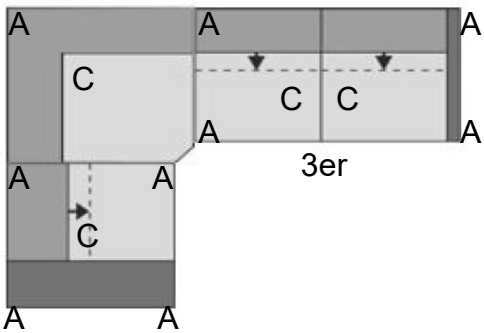
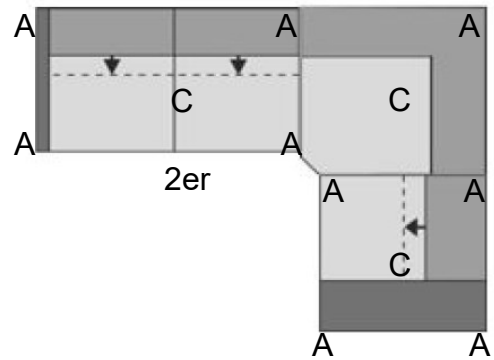
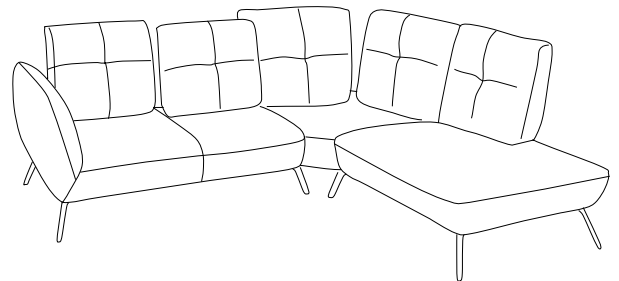
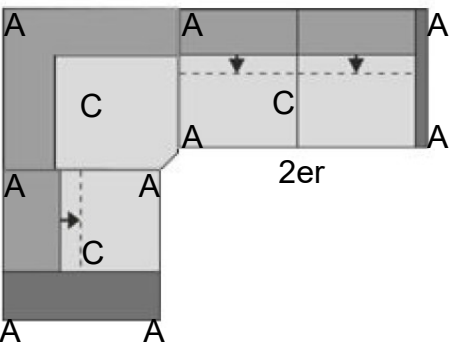
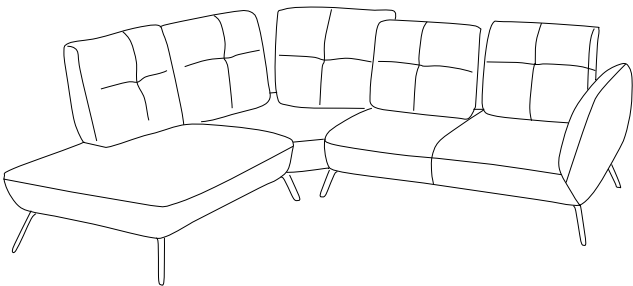
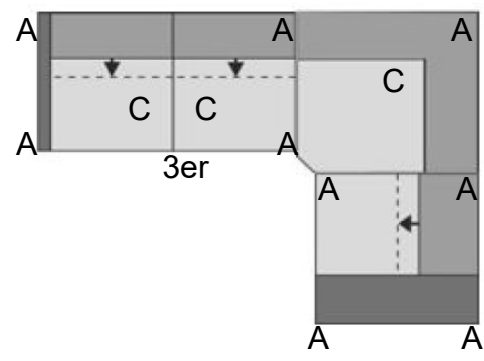
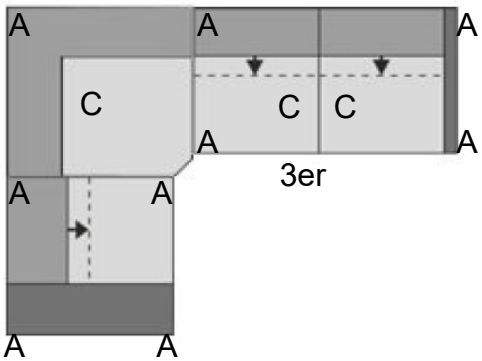
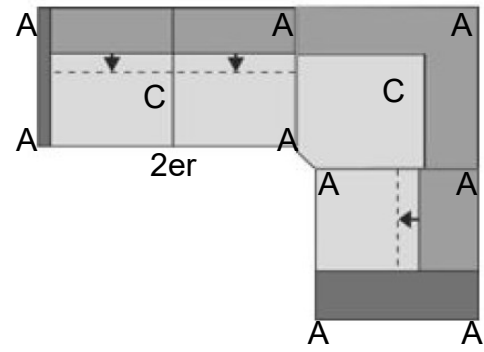
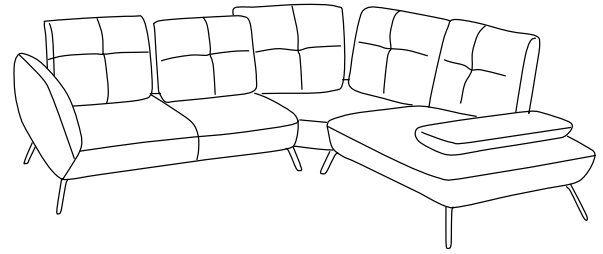
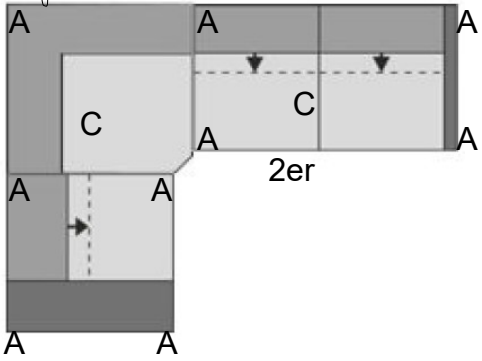
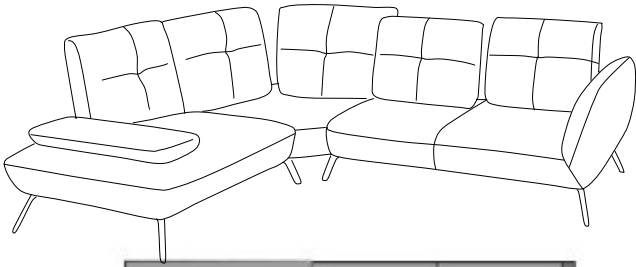

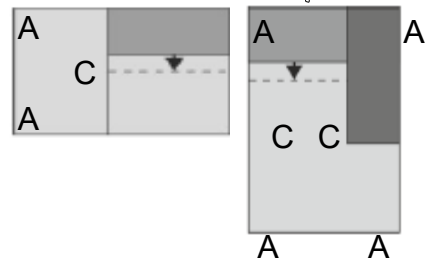
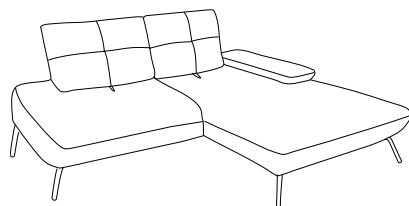
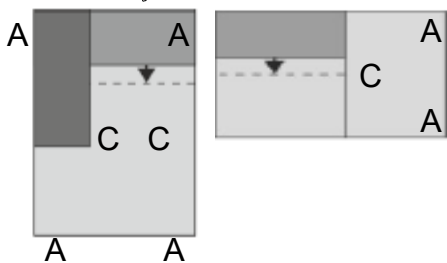
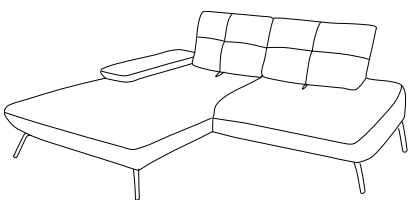
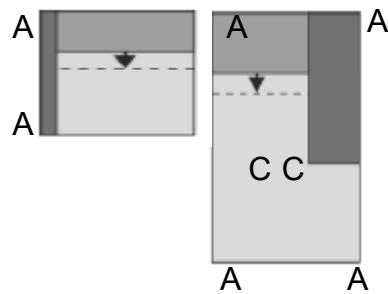
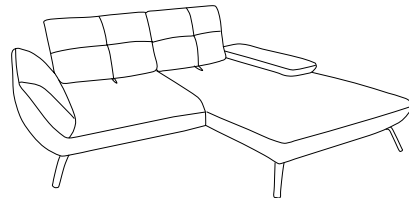
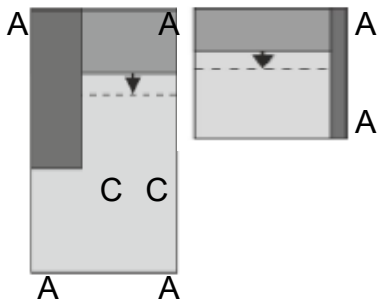
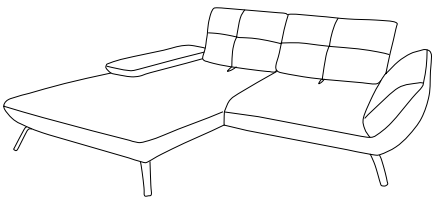
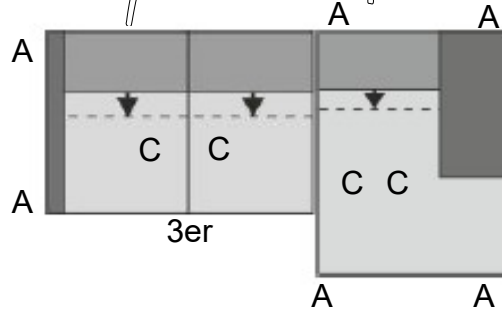
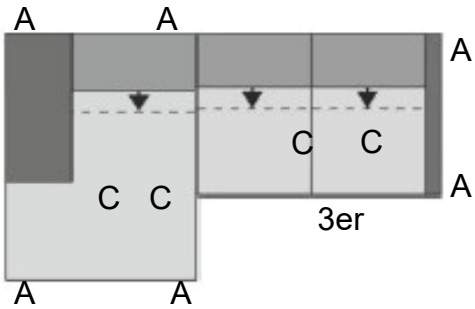
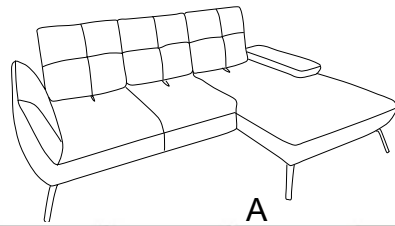
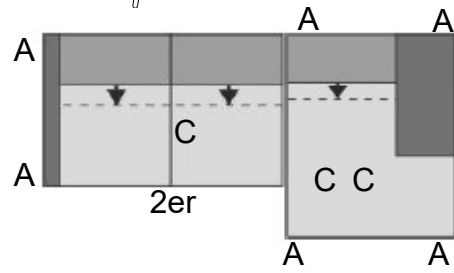
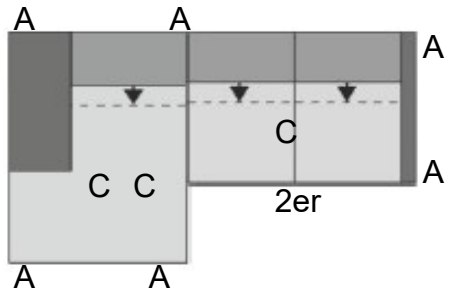
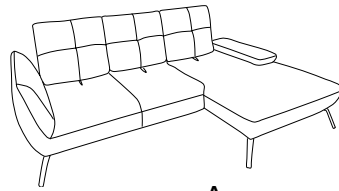



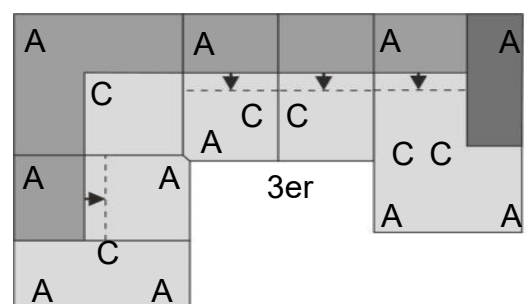
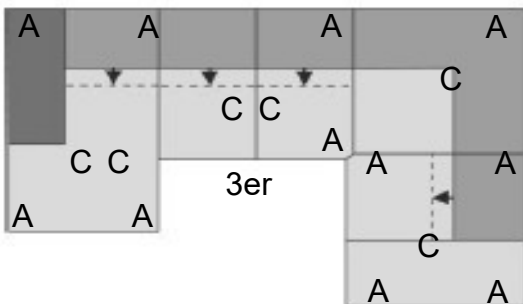
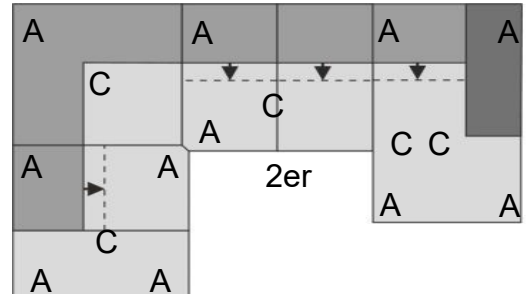
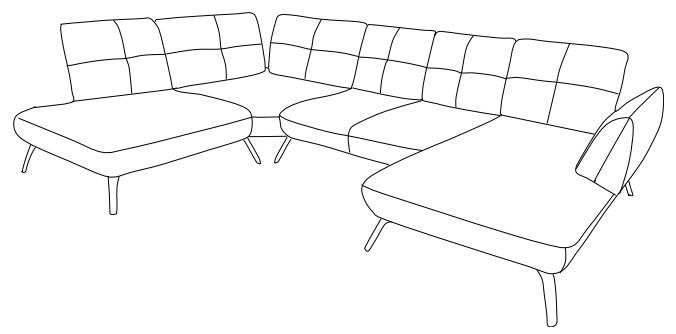
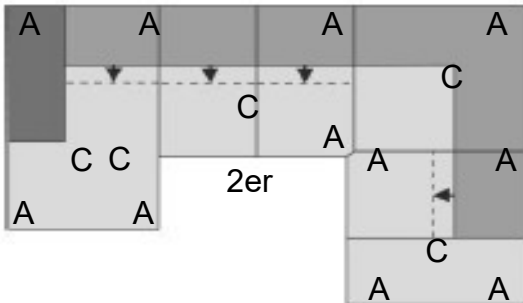
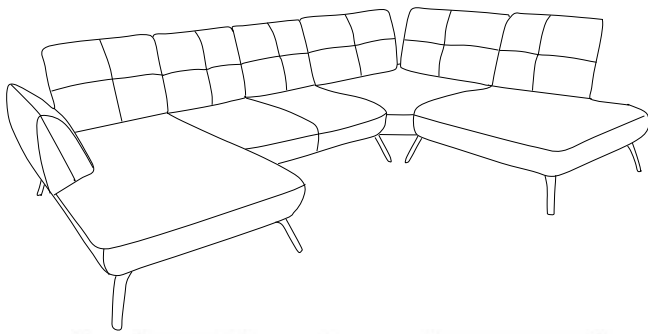
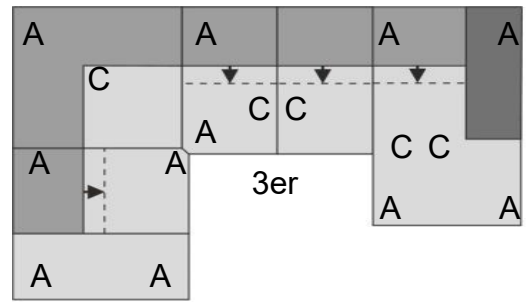
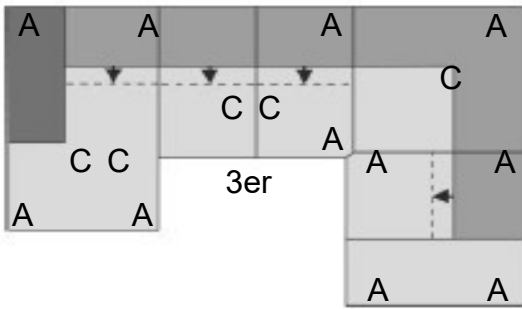
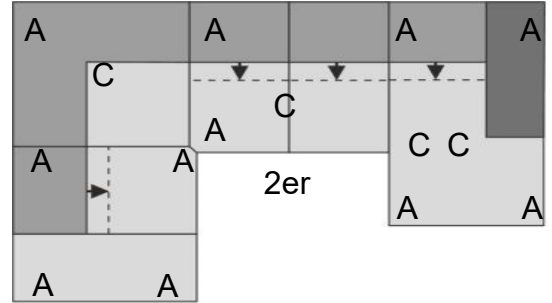
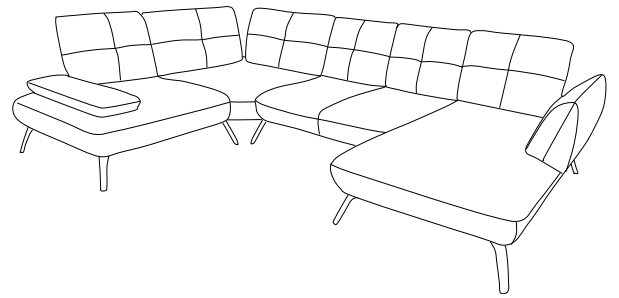
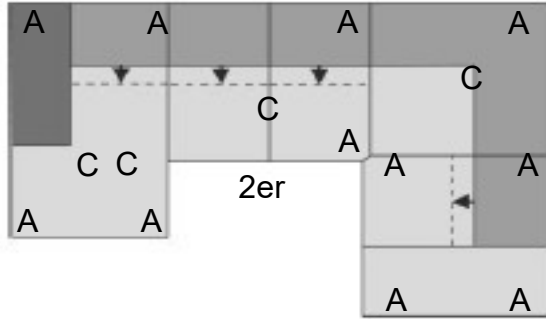
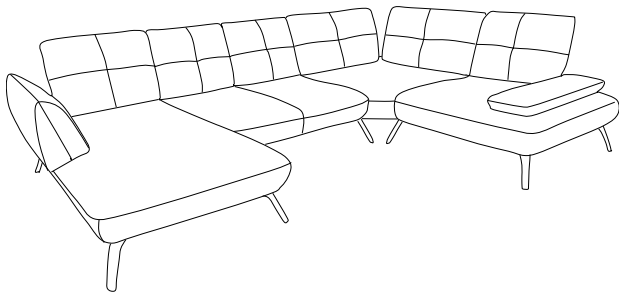

1

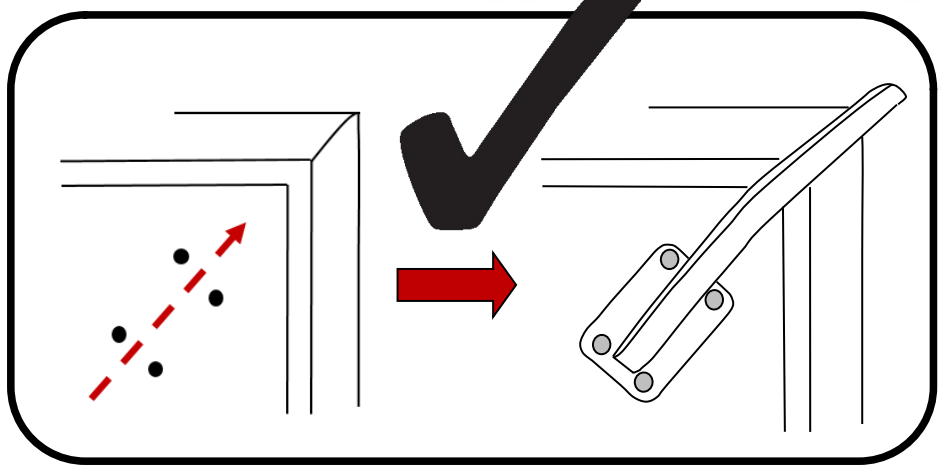
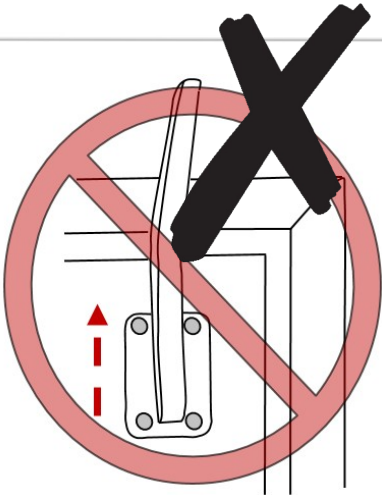
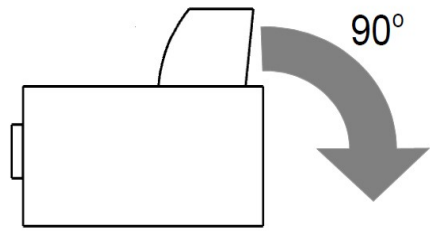

2

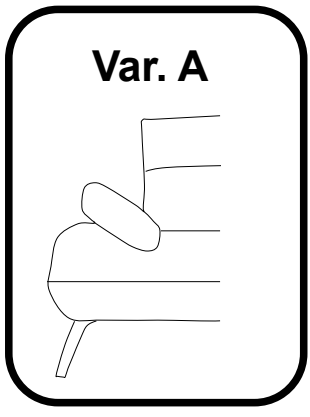

A

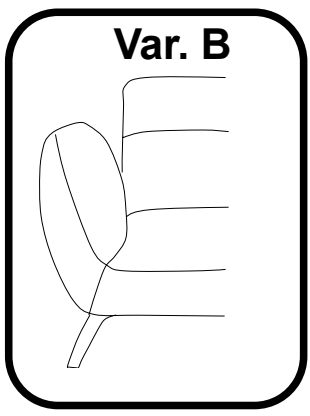
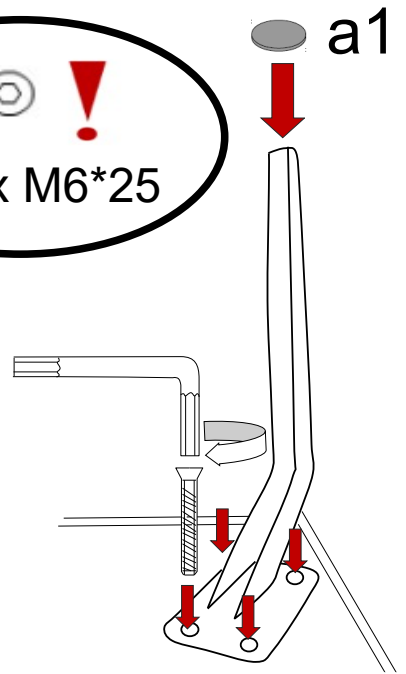
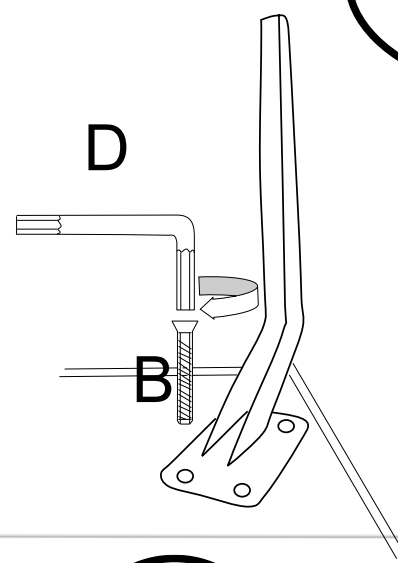
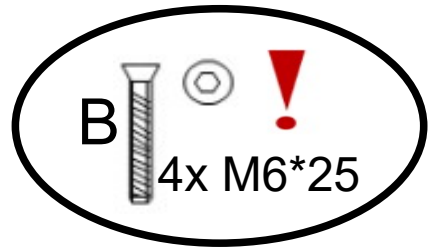

A

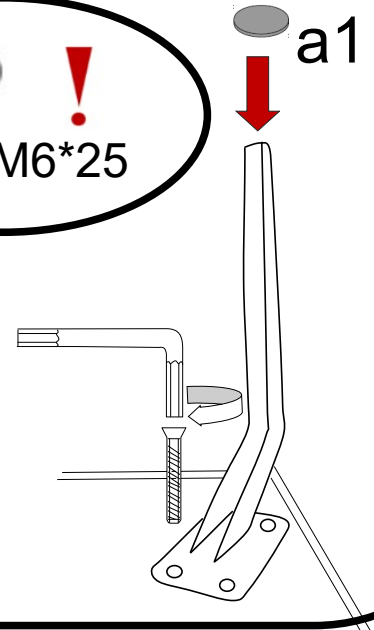
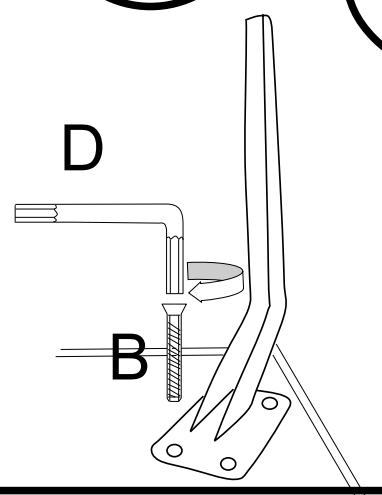
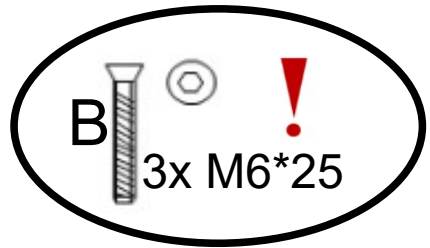

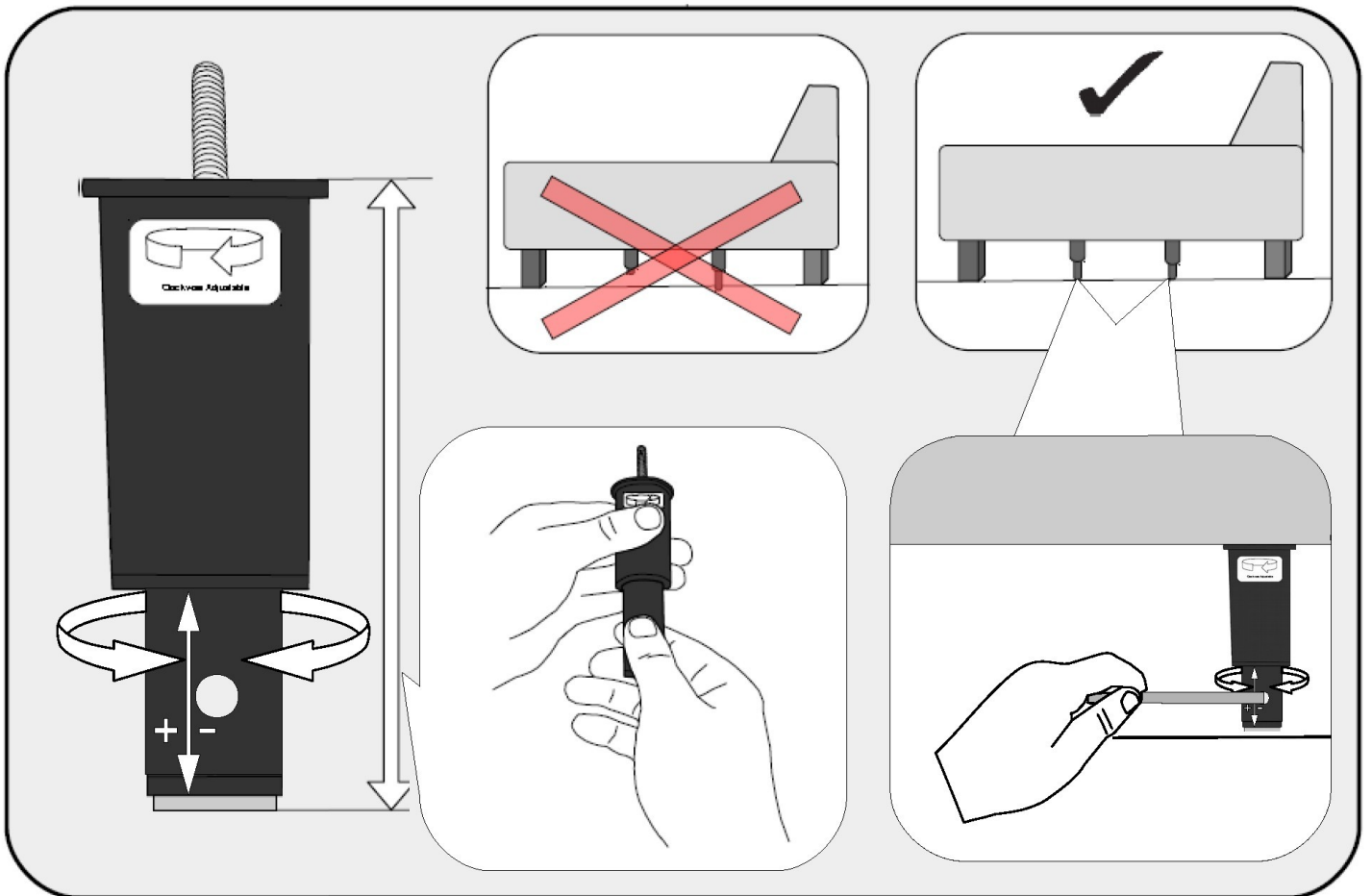
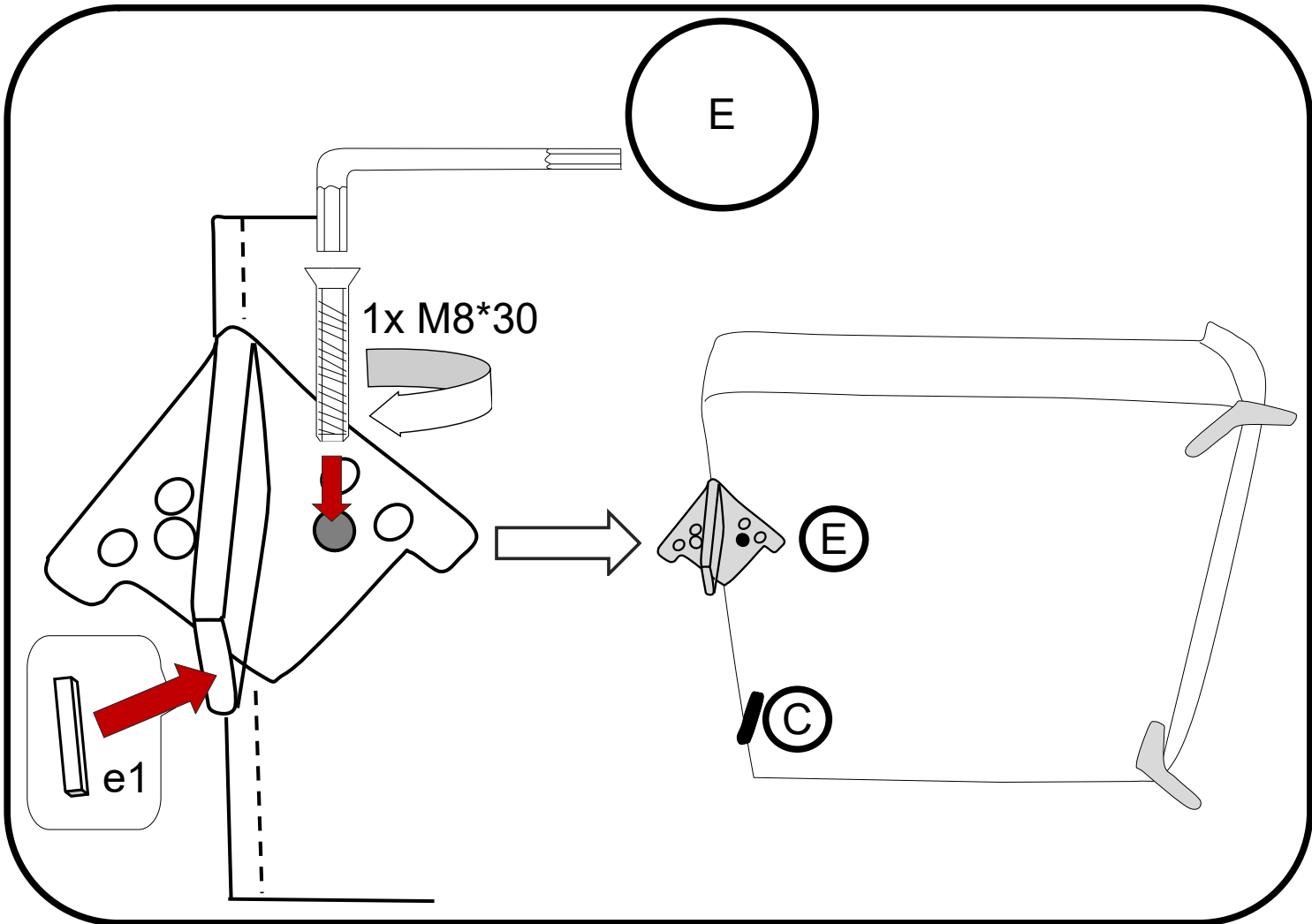

3

